



OPERATING GUIDE

IP ADVANCED RADIO SYSTEM
IP501M

INTRODUCTION

1. BEFORE USING

2. BASIC OPERATION

3. ADVANCED OPERATION

4. SET MODE

5. OPTIONS

6. FOR YOUR INFORMATION

INTRODUCTION

Thank you for choosing this Icom product.

This product is designed and built with Icom's state of the art technology and craftsmanship.

With proper care, this product should provide you with years of trouble-free operation.

Features

- Communication throughout the Coverage of LTE (4G) and 3G Network
- Built-in Bluetooth® and GPS*
An external GPS antenna is supplied.
- An Ethernet port for data communication
- Text message reception and preprogrammed message transmission
- Emergency call and Lone Worker functions
- Noise Canceling function (TX only)

① This document is described based on the IP501M firmware version 1.0.XX.

Icom is not responsible for the destruction, damage to, or performance of any Icom or non-Icom equipment, if the malfunction is because of:

- Force majeure, including, but not limited to, fires, earthquakes, storms, floods, lightning, other natural disasters, disturbances, riots, war, or radioactive contamination.
- The use of Icom transceivers with any equipment that is not manufactured or approved by Icom.

ALL RIGHTS RESERVED. This document contains material protected under International and Domestic Copyright Laws and Treaties. Any unauthorized reprint or use of this material is prohibited. No part of this document may be reproduced or transmitted in any form or by any means, electronic or mechanical, including photocopying, recording, or by any information storage and retrieval system without express written permission from Icom Incorporated.

All stated specifications and design are subject to change without notice or obligation.

Icom, Icom Inc. and the Icom logo are registered trademarks of Icom Incorporated (Japan) in Japan, the United States, the United Kingdom, Germany, France, Spain, Russia, Australia, New Zealand, and/or other countries.

All other products or brands are registered trademarks or trademarks of their respective holders.

Supplied accessories	1-2
Rear panel connection.....	1-3
Mounting the transceiver.....	1-5
Panel Description	1-6
■ Front Panel	1-6
◇ DIAL.....	1-6
◇ Indicators.....	1-6
◇ Operating keys	1-7
■ Function Display	1-8

Supplied accessories

Speaker microphone

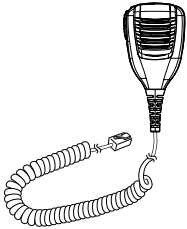

Mounting bracket

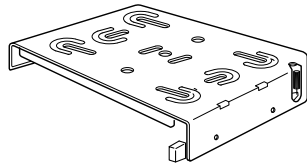

LTE antennas (with cleaning cloth)

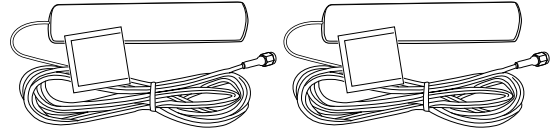

GPS antenna and double-sided adhesive pad

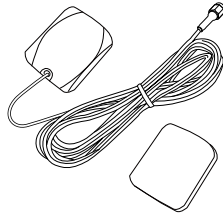

DC power cable



Microphone hanger and screw set

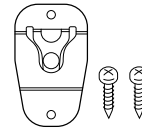

Cushion and sheet for the mounting bracket

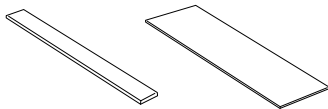

Spare fuses (5A)



Terminals for DC power cable (R2-6)



Mounting screws (M5×12 mm)

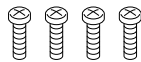

Self-tapping screws (M5×20 mm)

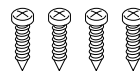

Flat washers



Spring washers



Nuts



Rear panel connection

NOTE: Keep at a distance of 20 cm (8 inches) or more between the LTE antenna of this device and any persons during operation.

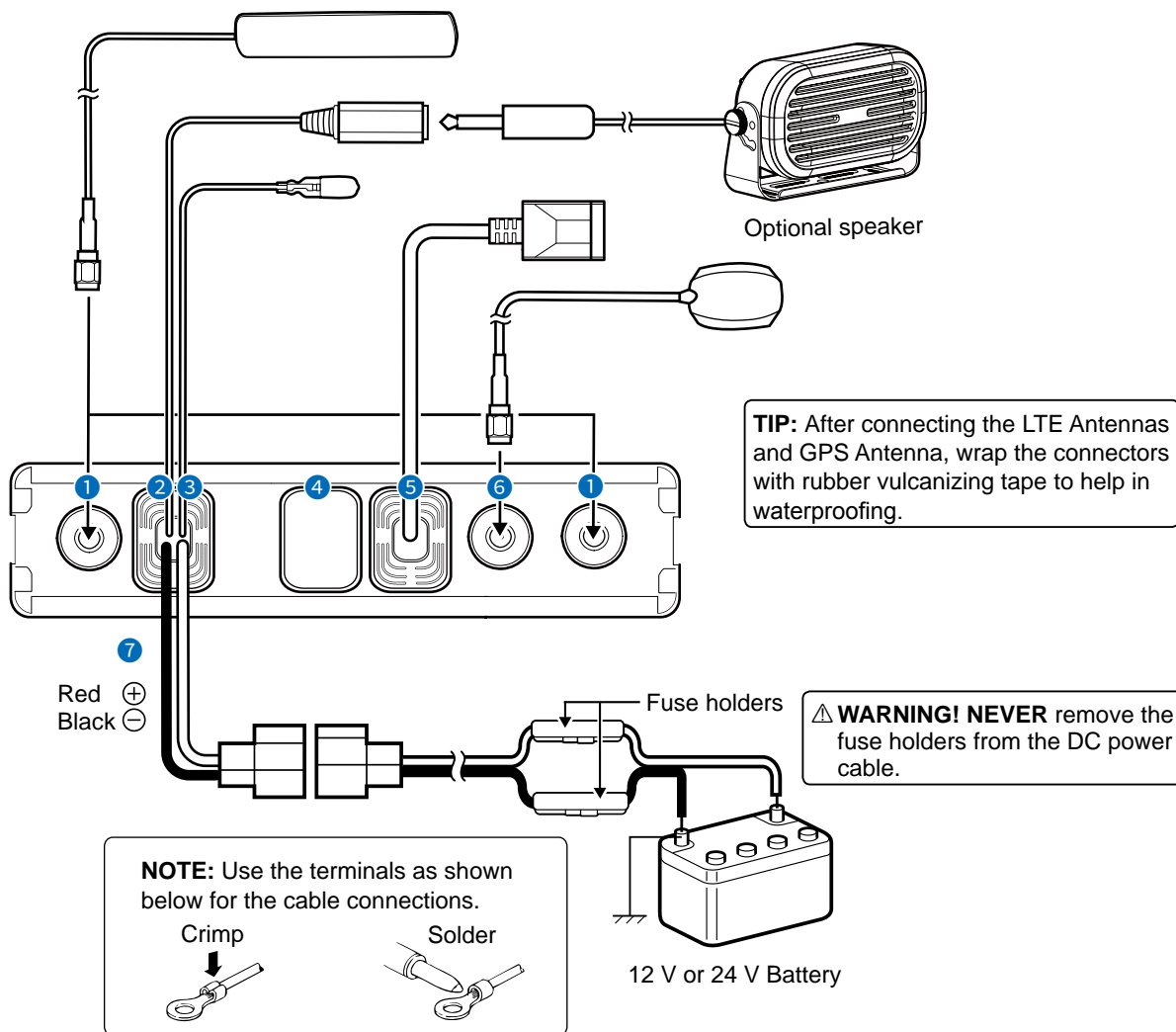

1 LTE ANTENNA CONNECTORS

Connect to the supplied LTE antenna. Contact your dealer about antenna placement.

NOTE:

- Keep at a distance of 30 cm (12 inches) or more between the LTE antennas during operation.
- Be sure the LTE antennas are positioned where they have a clear view to receive signal, and fixed using the adhesive pad.

2 EXTERNAL SPEAKER JACK

Connect a 4 ~ 8 Ω external speaker.

3 IGNITION LEAD

Connect to an ignition line.

CAUTION: DO NOT put pressure on this lead. Binding to the DC power cable is recommended.

4 D-Sub 25-pin

Remove the cover and connect the optional OPC-2407 ACC CABLE.

1 BEFORE USING

Rear panel connection

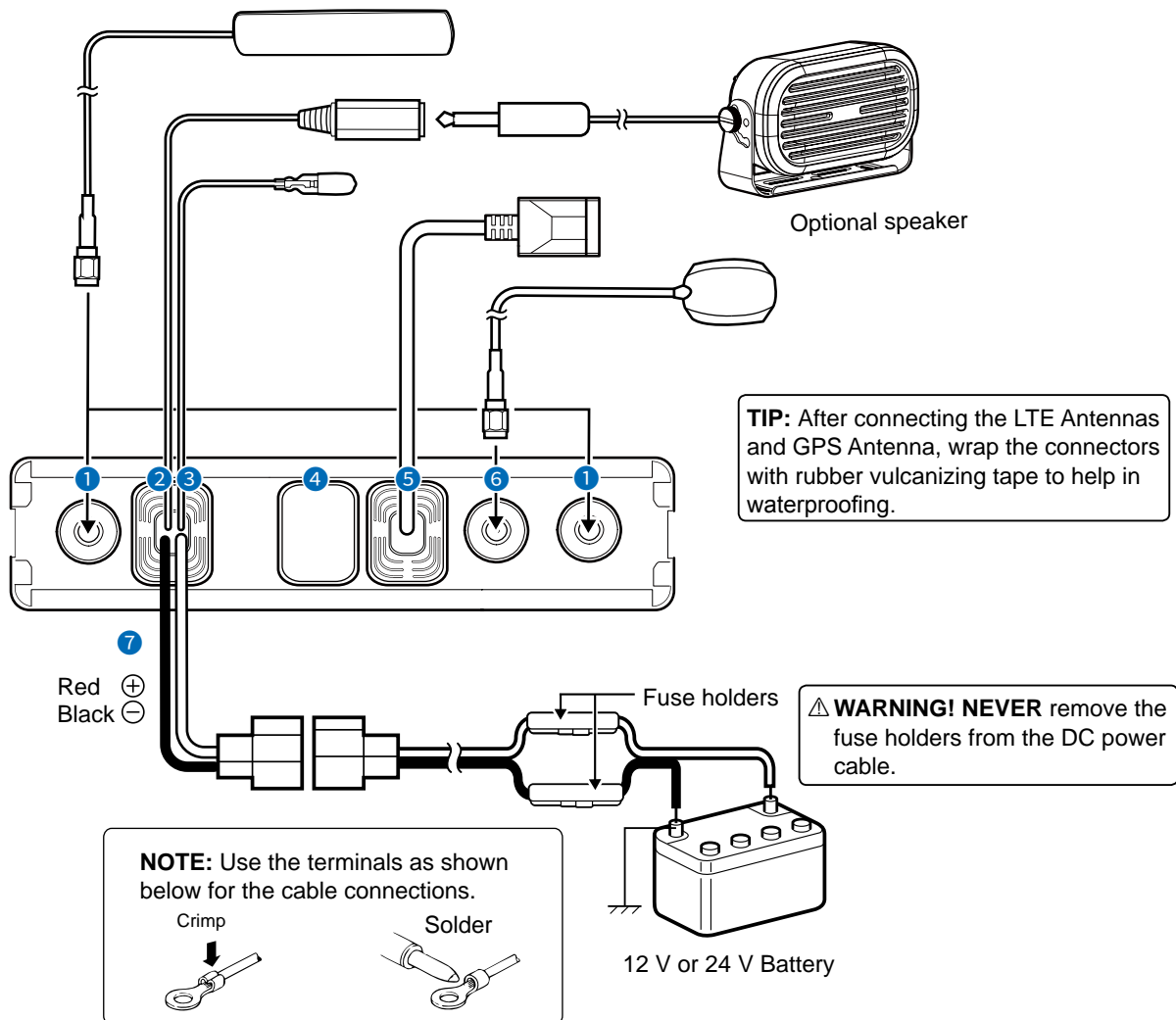

5 LAN CABLE.....

Connect the network devices such as a switch.

CAUTION: DO NOT connect other than network devices, such as microphone. This could damage the transceiver.

6 GPS ANTENNA CONNECTOR

Connect the supplied GPS antenna.

NOTE: Be sure the GPS antenna is positioned where the GPS antenna has a clear view to receive signal from satellites, and fixed using the supplied double-sided adhesive pad.

7 DC POWER CONNECTOR

Connect to a 12 V or 24 V DC battery.

Pay attention to polarities. Red line: ⊕, Black line: ⊖

CAUTION: DO NOT reverse the DC power cable polarity when connecting to a power source. This could damage the transceiver.

Mounting the transceiver

The universal mounting bracket supplied with your transceiver enables various mounting positions. Mount the transceiver securely with the 4 supplied screws to a thick surface which can support more than 1.5 kg (3.3 lb).

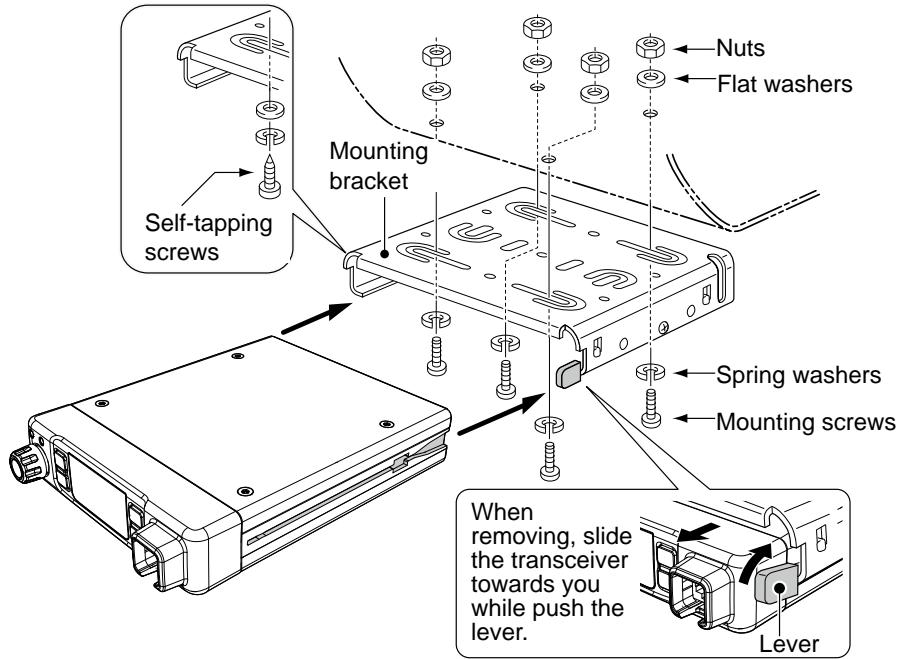

To reduce vibration, place the cushion on the transceiver and put the sheet on it.
① When mounting the bracket on the bottom side, attach a cushion and a sheet to the bottom of the transceiver.

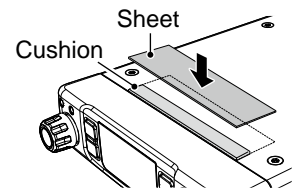

Panel Description

Front Panel

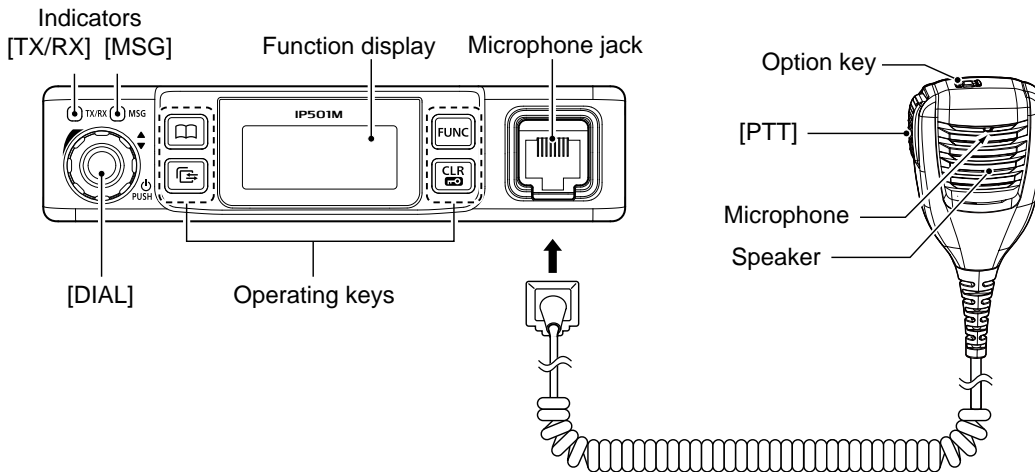

◇ DIAL

Hold down for 1 second to turn the transceiver ON or OFF.

- On standby screen: Rotate to adjust the audio volume.
- Others: Rotate to select an item.

◇ Indicators

[TX/RX] Lights red: Transmitting
 Lights green: Receiving
 Lights orange: Receiving and transmitting

[MSG] Reserved for a future function.

◇ Speaker microphone

The speaker microphone works as shown below when you hang (On-hook) or remove (Off-hook) it to or from the microphone hanger.

① The speaker microphone may work in a different way, depending on the presetting.

On-hook:

- End the call and return to standby screen.

Off-hook:

- When a call is received, remove the microphone to stop the receive tone.
- When the P-Bell function (p. 3-7) is enabled, remove the microphone to release the mute.

MICROPHONE HANGER

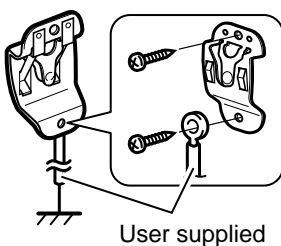

Connect the microphone hanger to the vehicle's ground for microphone ON/OFF hook functions when the microphone is used.

Panel Description

◇ Operating keys

Assigned key functions may differ, depending on the presetting.

[Address] key

- Selects a preset address.
- Push to toggle the Address Book between the call types.
- ① You can also toggle the address by rotate [DIAL].

All → Group (Talkgroup) → Individual

[Call History] key

- Push to display the call history.
- Push this key several times to toggle between the Call his types, Transmitted call, Received call, Sent message, and Received message.
- Hold down until "Emergency" is displayed to send an Emergency call.

[FUNC] key

- Push to select a Message, Status, Talkgroup, Bluetooth Pairing, UTC Offset function, Bluetooth One Touch PTT function, or Network Operator.
- Hold down for 3 seconds to enter the Set Mode function.

[CLR/Lock] key

- Push to return to the standby screen.
- Hold down for 1 second to turn the Key Lock function ON or OFF.
- ① [PTT] and [DIAL] are usable even while the Key Lock function is ON.

Panel Description

■ Function Display

Standby screen

Example: When receiving a custom message

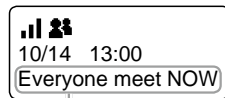
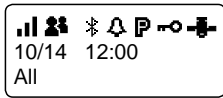

Scrolls, depending on the message length

📶 : Signal strength

The signal strength is represented by 3 bars.

- ① When the transceiver location is out of the service area, or cannot receive the control signal, the 📶 (out-of-area) icon blinks.
- ① If the IP501M has not been authenticated, 📶 is displayed.

👤 : Call types

Shows the call type.

Blinks when a call or message is received.

👤 : All/Group Call

👥 : Talkgroup Call*

👤 : Individual Call

☎ : Phone Call*

* May be usable, depending on a presetting.

📶 : Bluetooth (p. 5-5)

Displayed when the transceiver is connected to Bluetooth device.

🔔 : Pocket beep (p. 3-7)

- Displayed when the Pocket Beep function is ON.
- Blinks when a call is received. This icon blinks until the transceiver return to the standby mode after a received signal disappears.

🔔 : P-Bell (p. 3-7)

Displayed when the P-Bell function is used.

🔒 : Key Lock

Displayed when Key Lock function is ON.

📶 : GPS

- Displayed when valid position data is received.
- Blinks when searching for satellites or calculating position data.

Basic operation	2-2
■ Turning the transceiver ON or OFF	2-2
■ Receiving and Transmitting	2-2
Using the Address book	2-3
◇ Selecting a call-to party from the Address book.....	2-3
◇ Selecting a call-to party from the Call history	2-3

Basic operation

■ Turning the transceiver ON or OFF

Turning ON:

Hold down [DIAL] for 1 second to turn ON the transceiver.

- The standby screen is displayed as shown to the right.

① It may take a few minutes to boot up the transceiver for the first time.

Turning OFF:

Hold down [DIAL] for 1 second to turn OFF the transceiver.

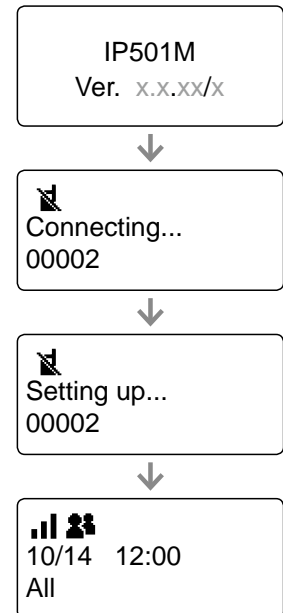

■ Receiving and Transmitting

Receiving:

When a Call is received, the [TX/RX] indicator lights green.

Rotate [DIAL] to adjust the audio output level to a comfortable listening level.

① When the volume is "0," key beeps and ringer tones do not sound.

Transmitting:

While holding down [PTT], speak at your normal voice level.

- The [TX/RX] indicator lights red while [PTT] is pushed.

Talk while receiving a call:

While receiving a call, push [PTT] to talk in the Full-Duplex mode* like a telephone call.

- In the Full-Duplex mode, the [TX/RX] indicator lights orange.

① Rotate [DIAL] to adjust the audio output level.

DO NOT cover the speaker or microphone.

* Depends on a presetting. Ask your dealer for details.

IMPORTANT:

To maximize the readability of your signal:

1. After pushing [PTT], pause briefly before you start speaking.
2. Hold the microphone 5 ~ 10 cm (2 ~ 4 inches) from your mouth, then speak at your normal voice level.

About the Time-out Timer:

When the continuous transmission period exceeds 5 minutes, the Time-out Timer automatically stops the transmission to prevent prolong transmissions. Release the [PTT], then hold down again to resume talking.

Using the Address book

You can select a call-to party from the Address book or Call history.

◇ Selecting a call-to party from the Address book

The [Address] key can be used, depending on a preset. Ask your dealer for details.

About the call type:

All call: Transmit to all of the transceivers that belongs to the network.

Group call: Transmit to the transceivers that belongs to the same group.

Talkgroup call: See page 3-4 for details.

Individual call: Transmit to an individual transceiver.

Telephone call: Transmit to an IP phone.*

*Transmittable, depending on the presetting.

1. Push [Address] to display the Address book.
 - The Address book is displayed.
2. Push [Address] several times to toggle the call type.
 - ① Displayed call type may differ, depending on the presetting.

All → Group → Individual → Telephone

3. Rotate [DIAL] to select a call-to party.
4. While holding down [PTT], speak at your normal voice level.

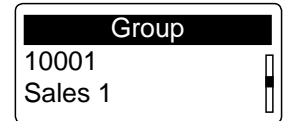

◇ Selecting a call-to party from the Call history

The transceiver's each Call history stores a maximum of 10 logs.

1. Push [Call History] to display the Call history.
 - The Call history is displayed.
2. Push [Call History] several times to toggle the log.
 - ① Displayed log may differ, depending on the presetting.

Tx log → Rx log → Tx MSG log → Rx MSG log → Tx Call log → Rx Call log

3. Rotate [DIAL] to select a call-to party.
4. While holding down [PTT], speak at your normal voice level.

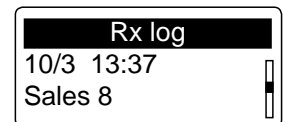

NOTE: You can delete logs in the Set mode. See page 4-3 for details.

Sending a message (Message Call)	3-2
■ Selecting a call-to party	3-2
■ Sending a message	3-2
◇ Sending a preset message.....	3-2
◇ Creating and sending a message using the optional HM-230HB.....	3-2
Browsing received messages.....	3-3
Status Call	3-3
Searching the ID List using the optional HM-230HB	3-3
About the Talkgroup Call	3-4
◇ Selecting a Talkgroup number.....	3-5
Emergency Call function	3-6
Other functions	3-7
◇ Pocket Beep function	3-7
◇ P-Bell function	3-7
◇ Lone Worker function	3-7

Sending a message (Message Call)

You can send a message, depending on a presetting. Ask your dealer for details.

■ Selecting a call-to party

1. Push [Address] to display the Address book.
 - The Address book is displayed.
2. Push [Address] several times to toggle the call type.
 - ① Displayed call type may differ, depending on the presetting.

All → Group → Individual → Telephone

3. Rotate [DIAL] to select a call-to party.

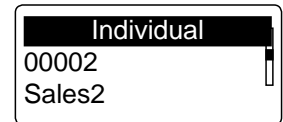

TIP: You can select a call-to party also from Call history.

1. Push [Call History] to display the Call history.
 - The Call history is displayed.
2. Push [Call History] several times to toggle the Call history from “Tx log,” “Rx log,” or “TX MSG log.”
 - ① Displayed log may differ, depending on the presetting.

Tx log → Rx log → Tx MSG log → Rx MSG log → Tx Call log → Rx Call log

3. Rotate [DIAL] to select a call-to party.

■ Sending a message

◇ Sending a preset message

1. Push [FUNC] to display the Function.
 - The Function is displayed.
2. Push [FUNC] to display “Message,” if the other function is displayed.
 - ① May be required to push [FUNC] several times, depending on the presetting.
3. Rotate [DIAL] to select a message to send.
 - The selected message may scroll, depending on the message length.
4. Push [PTT] to send a message.
 - ① “No Response” is displayed if the transmission failed.

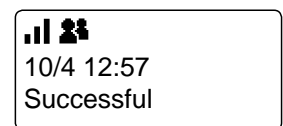
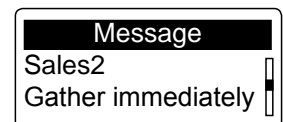

◇ Creating and sending a message using the optional HM-230HB

You can create and send a message, depending on the presetting.

① An optional HM-230HB command microphone (p. 5-3) is required.

1. Push an Option key that is assigned as a shortcut to the “Create Message.”



2. Create a message using the keypad.

TIP:

- Push [FUNC] to change the entry mode (“ABC” or “123”).
- Push [◀] or [▶] move the cursor.
- Push [▲] or [▼] to select a preset message to insert.
- Push [CLR/Lock] to delete an entered character.
- Hold down [CLR/Lock] to delete all characters.



3. Push [PTT] to send a message.

Browsing received messages

You can browse received messages, depending on the presetting. Ask your dealer for details.

1. Push [Call History] to display the Call history.
 - The Call history is displayed.
2. Push [Call History] to display “Rx MSG log.”
 - ① May be required to push [Call History] several times, depending on the presetting.
3. Rotate [DIAL] to browse received messages.
 - ① The selected message may scroll, depending on the message length.

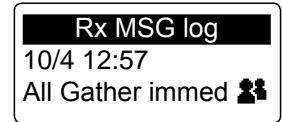

Status Call

You can send a Status call depending on a presetting. Ask your dealer for details.

1. Push [FUNC] to display the Function.
 - The Function is displayed.
2. Push [FUNC] to display “Status,” if the other function is displayed.
 - ① May be required to push [FUNC] several times, depending on the presetting.
3. Rotate [DIAL] to select a status.
4. Push [PTT] to send a status.

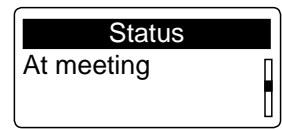

Searching the ID List using the optional HM-230HB

You can search an ID in the Address book, depending on the presetting. Ask your dealer for details.

① An optional HM-230HB command microphone (p. 5-3) is required.

1. Push [Address] to display “Search ID List.”
2. Enter an ID using the keypad.

TIP:

- Push [FUNC] to change the entry mode (“ABC” or “123”).
- Push [◀] or [▶] move the cursor.
- Push [CLR/Lock] to delete an entered character.
- Hold down [CLR/Lock] to delete all characters.



3. Push [▲] or [▼] to display and select the found ID list.

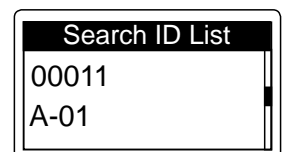

About the Talkgroup Call

The Talkgroup Call function enables the user to communicate with call-to parties in the same Talkgroup. For example, in the illustration below, when IP501M “00004” in its normal group “10001,” it selects Talkgroup “20001,” it is excluded from group “10001,” and can communicate with only IP501Ms “00006” and “00008” that belong to the Talkgroup “20001.”

- ① This function can be used for only when the Talkgroup number is registered, and the Talkgroup Call function is assigned to a key by your dealer.
- ② Ask your dealer about whether or not to include the Talkgroup in the All Call.

When Talkgroup is OFF

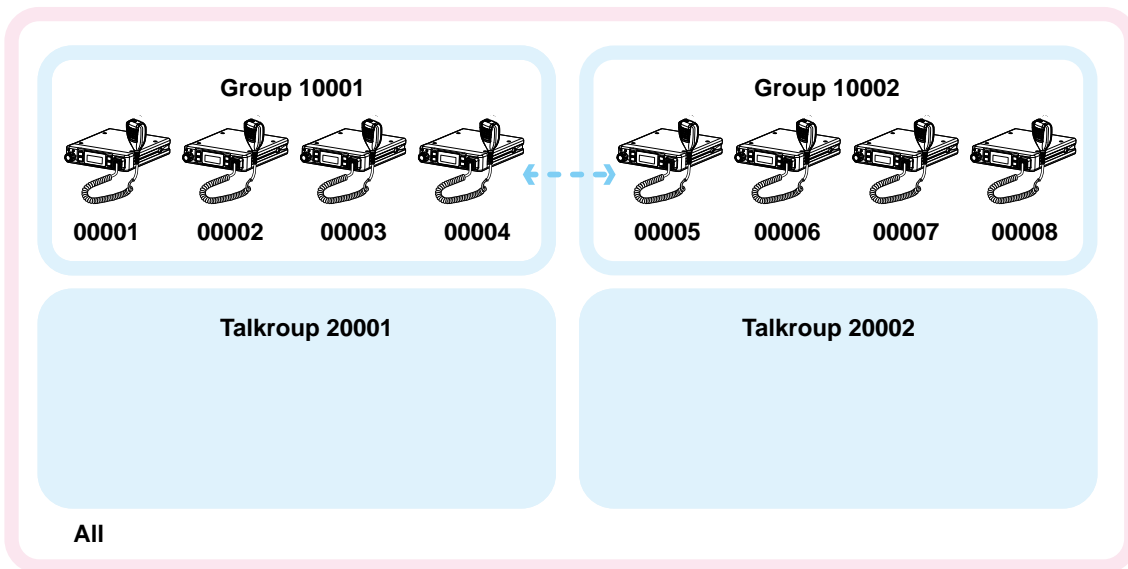

When Talkgroup is selected

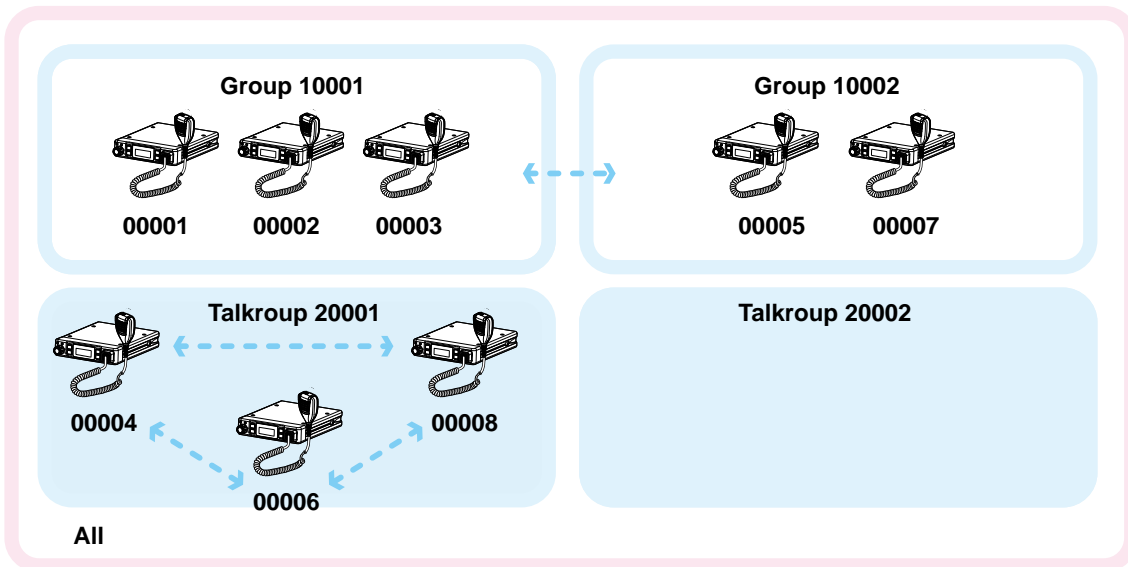

About the Talkgroup Call

◆ Selecting a Talkgroup number

You can select a Talkgroup number if the Talkgroup Call function is assigned to the [FUNC] or [Address] key. Ask your dealer for details.

Selecting with a [FUNC] key:

1. Push [FUNC] to display the Function.
 - The Function is displayed.
2. Push [FUNC] to display "Talkgroup," if the other function is displayed.
 - ① May be required to push [FUNC] several times, depending on the presetting.
3. Rotate [DIAL] to select a Talkgroup number that you want to belong.
4. Push [CLR/Lock].
 - The transceiver is ready to talk to only the transceivers that belong to the same Talkgroup.
 - ① While the Talkgroup number is selected, you cannot transmit Normal Group call.
 - ① You can leave the Talkgroup and return to the Normal Group by selecting "OFF" in Step 2 on the "Talkgroup" screen.

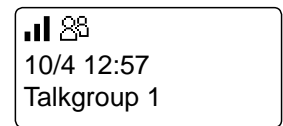
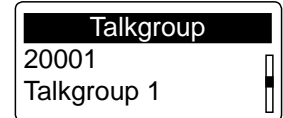

Selecting with a [Address] key:

1. Push [Address] to display the Address book.
 - The Address book is displayed.
2. Push [Address] several times to display "Group" or "Talkgroup."
3. Rotate [DIAL] to select a Talkgroup number that you want to belong.
4. Push [CLR/Lock].
 - The transceiver is ready to talk to only the transceivers that belong to the same Talkgroup.
 - ① While the Talkgroup number is selected, you cannot transmit Normal Group call.
 - ① You can leave the Talkgroup and return to the Normal Group by selecting "OFF" in Step 2 on the "Talkgroup" screen.

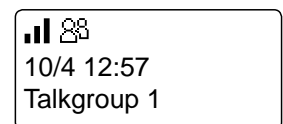
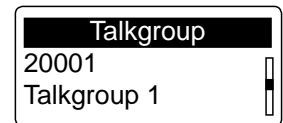

Emergency Call function

You can receive or transmit Emergency Call if the function is assigned to the Option key or [Call History] key. Ask your dealer for details.

Transmitting:

① The instruction is based on the case that the function is assigned to the Option key.

1. Hold down the Option key until “Emergency” is displayed.
 - An alarm sounds periodically.
 - ① If the Silent mode is enabled by your dealer, no alarm sounds, and no emergency indication is displayed.
2. Wait for the answer-back.
 - When the transceiver receives an answer-back, the alarm stops, and the [TX/RX] indicator lights green.
 - ① To cancel the emergency call, hold down the Option key until “Emergency” disappears, or turn OFF the transceiver.

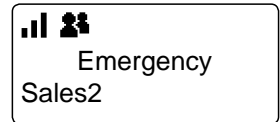

Receiving:

1. “Emergency” is displayed and the alarm periodically sounds.
 - ① When the Silent mode is enabled by your dealer, no alarm sounds.
2. While holding down [PTT], talk into the microphone.
 - While holding down [PTT], the [TX/RX] indicator lights red.
 - The alarm stops.
 - Returns to the Standby screen when you release [PTT].

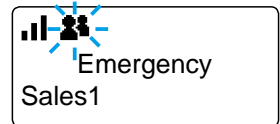

NOTE: The Emergency function may not properly work, depending on the surrounding environment such as obstructions, weather condition, and so on. Icom is not responsible for the destruction or damage caused by using the Emergency Call function.

Other functions

◇ Pocket Beep function

The Pocket beep function sounds a notification tone and indication when a call is received.

① This function is set by your dealer, or in the Set mode.

① "🔔" is displayed when the function is ON.

① "🔔" blinks and the notification beep sounds when a call is received. It blinks until the transceiver return to the standby mode after a received signal disappears.

◇ P-Bell function

The P-Bell function sounds the notification tone when a call is received.

A received call is muted until you reply. After pushing [PTT], the mute is released.

① This function is set by your dealer, or in the Set mode.

① "🔔" is displayed when the function is ON.

◇ Lone Worker function

When the Lone Worker function is activated, the Emergency Call function (p. 3-6) is automatically turned ON after the transceiver has been left without any operation for the specified period of time.

NOTE: The Lone Worker function may not properly work, depending on the surrounding environment such as obstructions, weather condition, and so on.

Icom is not responsible for the destruction or damage caused by using the Lone Worker function.

Using the Set mode	4-2
◇ Basic Set mode	4-2
◇ Detailed Set mode	4-2
◇ Using the Set mode	4-2
Set mode items	4-3

Using the Set mode

You can use the Set mode to set infrequently changed values or function settings. The transceiver has 2 types of Set mode, as shown below.

① You cannot transmit or receive while the transceiver is in the Set mode.

◇ Basic Set mode

- Hold down [FUNC] for 3 seconds to enter the Set mode.
- "SET" is displayed.

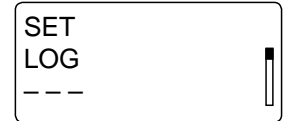

◇ Detailed Set mode

1. Hold down [FUNC] for 3 seconds to enter the Set mode.
 - "SET" is displayed.
2. Hold down [FUNC] for 3 seconds again to enter the Detailed Set mode.
 - "SET (Detail)" is displayed.

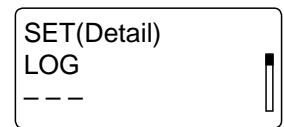

◇ Using the Set mode

1. Push [FUNC] or [Address] to select an item.
2. Rotate [DIAL] to select an option.
 - ① Pushing [Call History] may be required to apply the selected option. See page 4-3 to 4-6 for details.
3. Push [PTT] or [CLR/Lock] to exit the Set mode.

Set mode items

The shaded items are also displayed in the Basic Set mode.

① Items or default values may be different, depending on the transceiver's version or presets. Ask your dealer for details.

Item	Description	Option/range	Default
LOG	Deletes logs. ① Select "CLR," and then push [Call History] to delete.	---, CLR	---
RESET	Resets the transceiver to its defaults, except for the Bluetooth pairing list. ① Select "YES," and then push [Call History] to reset. ① The transceiver automatically restarts.	NO or YES	NO
FIRM UP	Updates the transceiver's firmware. ① Select "YES," and then push [Call History] to reset. ① The transceiver automatically restarts. ① Updating the firmware takes approximately 10 minutes.	NO or YES	NO
Success Tone	Selects whether or not to enable the tone that indicates an individual call was successfully transmitted. ① The transmission result is also displayed on the screen.	Enable or Disable	Enable
Failure Tone	Selects whether or not to enable the tone that indicates an individual call failed. ① The transmission result is also displayed on the screen.	Enable or Disable	Enable
Call Tone (IND/GRP/ALL/ TEL)	Sets the Call Initiation tone.	Disable, Tone1 ~ Tone8 ① Larger number makes the tone lower.	Tone1 (Pi)
Crtsy Beep (IND/GRP/ALL/ TEL)	Sets the Call Termination beep.	Disable, Tone1 ~ Tone8 ① Larger number makes the beep lower.	Tone1 (Pi)
RX Tone (IND/GRP/ALL/ TEL/MSG)	Sets the Call Receive tone.	Disable, Tone1 ~ Tone8 ① Larger number makes the tone lower.	Disable
Notify Type (IND/GRP/ALL/ TEL)	Sets the call receive notification type.	P-Bell or Pocket beep	P-Bell
Notify No. (IND/GRP/ALL/ TEL/MSG)	Sets the number of tones.	Continuous (Except for "MSG"), 1, 3, 10, 20 (times)	3 (times)
RX Notify Vol.	Sets the call or message received notification volume.	0 ~ 32	10
Out of Rng Tone	Selects whether or not to enable the Out-of-Area Warning Beep. The beep also sounds when the transceiver reenters the service area. (Out-of-area: "Pipi," Reenters: "Popo")	Disable or Enable	Disable
VOX	Selects a VOX function option. The function automatically switches between receive and transmit by detecting your voice.	Disable, Bluetooth Mic	Disable

4 SET MODE

Set mode items

The shaded items are also displayed in the Basic Set mode.

① Items or default values may be different, depending on the transceiver's version or presets. Ask your dealer for details.

Item	Description	Option/range	Default
VOX Threshold	Sets the VOX threshold level. ① Lower values make the VOX function more sensitive to your voice.	0% ~ 100%	40%
Echo Canceller	Selects whether or not to enable the Echo Cancelling function. ① Commonly used for an earphone MIC, and headset.	Enable or Disable	Enable
Noise Canceller	Selects whether or not to enable the Noise Cancelling function. ① Commonly used for a transceiver, earphone MIC, and headset.	Enable or Disable	Enable
BackLight	Selects a Backlight option.	Auto (Key), ON, OFF, Dim, Auto (Dim)	ON
BackLight MIC	Selects an HM-230HB's Backlight option. ① Displayed only when an optional HM-230HB is attached.	Auto (Key), ON, or OFF	Auto (Key)
Contrast	Sets the screen contrast.	1 (lowest) ~ 16 (highest)	8
Contrast Mic	Sets the HM-230HB's screen contrast. ① Displayed only when an optional HM-230HB is attached.	1 (lowest) ~ 16 (highest)	8
Dimmer Mic	Sets the HM-230HB's dimmer level. ① Displayed only when an optional HM-230HB is attached.	0 (lowest) ~ 31 (highest)	31
Mic Gain	Sets the microphone sensitivity. ① Higher values make the microphone more sensitive to your voice.	-12 dB (lowest) ~ 12 dB (highest) (in 3 dB step)	0 dB
Notify Beep Vol.	Sets the Notification Beep level.	0 ~ 32	10
Key-Touch Beep	Selects whether or not to enable the Key-touch beep.	Enable or Disable	Enable
Key Beep Vol.	Sets the Key-touch beep level.	0 ~ 32	10
RX Buffer Type	Sets the Jitter buffer size. ① Jitter buffer reduces audio interruptions.	Dynamic, 40 ~ 480 milliseconds (in 40 milliseconds step)	Dynamic
Call Type Stnby	Selects whether or not to display the call-to party (Call type)* ³ on the standby screen. * ³ Preset by your dealer.	Enable or Disable	Enable
Destination ID	Selects a Destination ID display option. ① If "Disable" is selected, the call-to party (call type) that is preset by your dealer is displayed on the standby screen.	Disable, All Operations, Transmit and Receive, or Transmit	Disable
Bluetooth	Selects whether or not to enable the Bluetooth function.	Disable or Enable	Disable

4 SET MODE

Set mode items

The shaded items are also displayed in the Basic Set mode.

① Items or default values may be different, depending on the transceiver's version or presets. Ask your dealer for details.

Item	Description	Option/range	Default
BT Auto Connect* ¹	Selects whether or not to automatically connect a Bluetooth device.	Enable or Disable	Enable
BT Sync Vol.* ¹	Selects whether or not to synchronize the Bluetooth headset's volume level with the transceiver's volume level. ① When "Enable" is selected, the Bluetooth headset volume can be set by rotating [DIAL].	Disable or Enable	Disable
BT Connect Type* ¹	Selects the Synchronous Connection-Oriented (SCO) link* ⁴ connection type of a Bluetooth headset. When "Auto Disconnect" is selected, the SCO link is automatically disconnected after 2 seconds. * ⁴ A Bluetooth link for voice communication. ① This setting is valid only when a Bluetooth device other than a VS-3 is used. ① When this item is set to "Auto Disconnect," the VOX function is not usable.	Always Connect or Auto Disconnect	Always Connect
PTT & Mic Switch* ¹	Enables the user to select which microphone to use. ① When this item is set to "Auto," transmits the audio from the device whose [PTT] is pushed.	Auto, Bluetooth Mic, or Radio Mic	Auto
BT AF Output* ¹	Selects the AF Output device when a Bluetooth headset is connected.	BT Only, BT & SP	BT Only
BT Echo Canceller* ¹	Selects whether or not to enable the Bluetooth headset's Echo Canceller.	Enable or Disable	Enable
BT E-Cancel Gain* ¹	Sets the Echo Canceller input gain for a Bluetooth headset.	-40 dB ~ +40 dB	0 dB
BT E-Cancel Delay* ¹	Sets the Echo Canceller delay for a Bluetooth headset.	0milliseconds ~ 160milliseconds	35milli-seconds
BT Noise Cancel* ¹	Selects whether or not to enable the Bluetooth headset's Noise Canceller.	Enable or Disable	Enable
BT Power Save* ¹	Selects whether or not to enable the Bluetooth headset's Power Save function. ① When "Enable" is selected, the Power Save function automatically activates after 2 minutes of no communication.	Disable or Enable	Disable

*¹Displayed only when "Enable" is selected in the "Bluetooth" item.

4 SET MODE

Set mode items

The shaded items are also displayed in the Basic Set mode.

① Items or default values may be different, depending on the transceiver's version or presets. Ask your dealer for details.

Item	Description	Option/range	Default
BT One Touch PTT* ¹	Selects whether or not to enable the One-Touch PTT function while a Bluetooth headset is connected. The function toggles receiving and transmitting by momentarily pushing [PTT] on a Bluetooth headset. ① Push [PTT] to talk, and push again to return to receive. ① When "Enable" is selected, you do not have to hold down [PTT] while you are talking.	Disable or Enable	Disable
Show BT One Touch PTT* ¹	Selects whether or not to display the "BT One Touch PTT" item by pushing [FUNC] on the standby screen.	Disable or Enable	Disable
BT PTT Beep* ¹	Selects whether or not to sound a beep when the [PTT] on the Bluetooth headset is pushed.	Disable or Enable	Disable
Search BT Device* ¹	Searches for Bluetooth devices. ① Push [Call History] to start searching.	Search	–
Delete BT Device* ¹	Deletes paired devices.	–	–
Init BT Unit* ¹	Initializes the built-in Bluetooth unit and pairing list.	NO or YES	NO
BT Unit Version	Displays the built-in Bluetooth unit version.	–	–
Horn (Ext. I/O)* ²	Selects whether or not to enable the external horn that connected to an optional OPC-2407 ACC CABLE.	Disable or Enable	Disable
ID List Select Mode (Ext. I/O)* ²	Selects whether or not to enable selecting a talk-to-party from an external device connected to an optional OPC-2407 ACC CABLE.	Disable or Enable	Disable
UTC Offset* ³	Set the offset time between the UTC (Universal Time Coordinated) and local time.	–14:00 ~ +14:00 (in 1 minute steps)	00:00
Daylight Sav Time* ³	Selects whether or not to use Daylight Saving Time (DST) for the clock.	Disable or Enable	Disable
Show SIM Selection	Selects whether or not to display the "SIM Selection" item by pushing [FUNC] on the standby screen.	Disable or Enable	Disable
SIM Selection	Selects a SIM card. ① Rotate [DIAL] to select a SIM card, and then push [Call History] to restart the transceiver.	___* ⁵ (SIM1) * ⁵ A SIM card name is displayed, if it is named.	___ (SIM1)

*¹Displayed only when "Enable" is selected in the "Bluetooth" item.

*²Displayed only when the function is assigned to the OPC-2407's D-sub 25 pin by your dealer.

*³Displayed only when the transceiver uses the SNTP server for clock synchronization.

4 SET MODE

Set mode items

The shaded items are also displayed in the Basic Set mode.

① Items or default values may be different, depending on the transceiver's version or presets. Ask your dealer for details.

Item	Description	Option/range	Default
Show Network Select	Selects whether or not to display the "Network Select" item by pushing [FUNC] on the standby screen.	Disable or Enable	Disable
Network Select	Selects whether or not to automatically select a network carrier.	Auto, Last accessed, or User select	Auto
Network Search	Searches for a network carrier. ① Displayed only when "User select" is selected in the "Network Select" item.	Search	–
HM-230 Version	Displays an optional HM-230HB's firmware version, if it is connected.	–	–
LTE Unit Version	Displays the internal LTE unit version.	–	–
IMEI	Displays the Communication unit's IMEI number.	–	–
Phone Number	Displays the SIM card's telephone number.	–	–
ICCID	Displays the SIM card's ICCID.	–	–

Options	5-2
Using the HM-230HB command microphone	5-3
■ Connecting the HM-230HB	5-3
■ Panel description	5-3
Using the Bluetooth® device	5-4
■ About the VS-3 Bluetooth headset	5-4
■ Pairing with a Bluetooth device	5-5
■ Settings for the Bluetooth function	5-5
■ Disconnecting the paired device	5-6
■ Deleting a device from the Pairing list	5-6
■ Initializing the Pairing lists	5-7

Options

① Some options may not be available in all countries. Ask your dealer for details.

Microphones

- **HM-230HB** COMMAND MICROPHONE
- **HM-241** SPEAKER MICROPHONE
Same as supplied
- **SM-28** DESKTOP MICROPHONE

Headsets

- **VS-3** Bluetooth® HEADSET
The Bluetooth headset with a [PTT] switch.
- **About third-party Bluetooth headsets:**
Icom has checked the PTT operation with some 3M Peltor headsets such as the WS Headset XP, WS ProTac XP and WS Alert XP.
(Compatibility not guaranteed)

External speakers

- (Input impedance: 4 Ω)
- **SP-30** EXTERNAL SPEAKER
Rated input 20 W,
Maximum input 30 W,
Cable length: Approximately 2.8 m (9.2 feet)
 - **SP-35** EXTERNAL SPEAKER
Rated input 5 W,
Maximum input 7 W,
Cable length: Approximately 2 m (6.5 feet)

Cables

- **OPC-2355** EXTENSION CABLE
Extension cable for the microphone
Cable length: Approximately 2.5 m
- **OPC-1122U** PROGRAMMING CABLE
- **OPC-2407** ACC CABLE
D-sub 25-pin type

Using the optional HM-230HB command microphone

You can use the transceiver more comfortable using the HM-230HB COMMAND MICROPHONE.

■ Connecting the HM-230HB

Turn OFF the transceiver, and insert the HM-230HB connector into the microphone jack until it locks.

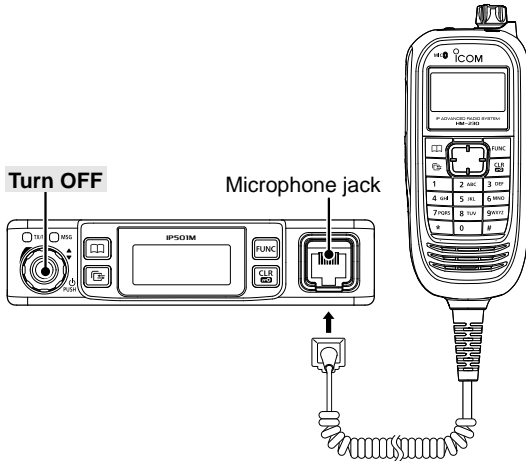

■ Panel description

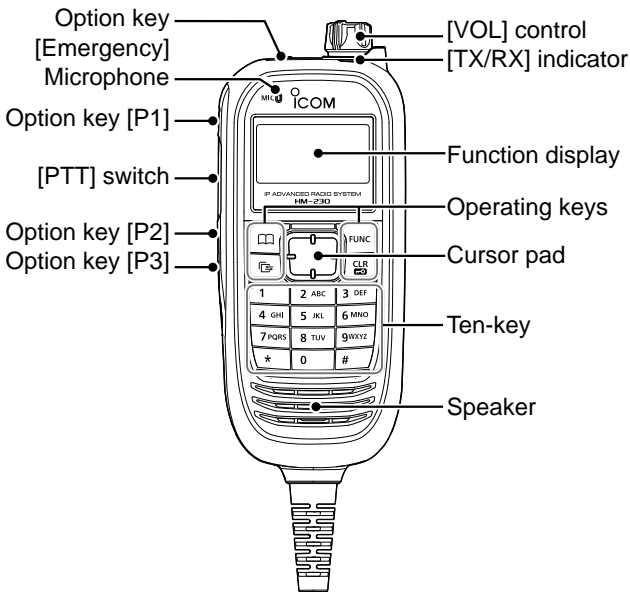

[TX/RX] indicator

- Lights red: Transmitting
- Lights green: Receiving a signal, or the squelch is open
- Lights orange: Transmitting and receiving in the full-duplex mode

Operating keys

The [Address], [Call History], [FUNC], and [CLR/Lock] keys on the HM-230HB work as the same as the keys on the transceiver (p. 1-7).

① Use the cursor pad to move the cursor or select an item.

Cursor pad

You can make a selection with the cursor pad in the menu, Address, Call History, Set mode, and so on.

- Push [◀] or [▶] to select an item, and push [▲] or [▼] to select an option.

Option keys [Emergency], [P1] ~ [P3]

A dealer can assign the Software Key functions to the Option keys (p.5-4).

Ten-key

① The usable functions differ, depending on the presetting. Ask your dealer for details.

You can enter a message or select an address to make a call. (p. 3-2)

Hold down the address number to directly select a call-to-party from the Address Book.

① To select an address number with more than 2 digits, push tens/hundreds place number, and then hold down ones place number.

Using the optional HM-230HB command microphone

■ Using Option keys

The function shown below may be usable by using Option keys, depending on the presetting. Ask your dealer for details.

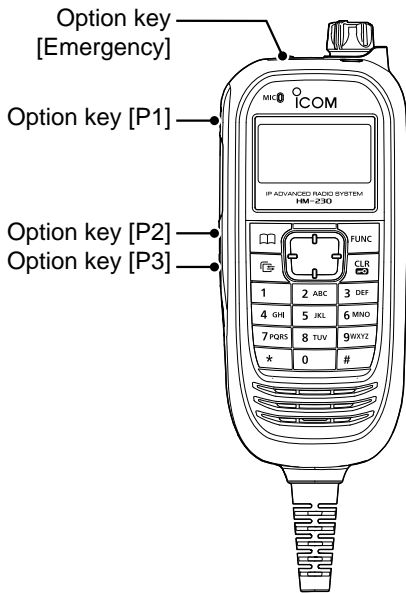

Function	Description
Message	Push an Option key to display the "Message." You can select a preset message to send. ① Push [▲] or [▼] to select a message.
Edit Message	Push an Option key to display the "Create Message." You can create and send a message (p. 3-2).
One Touch	Push an Option key to directly select a preset Call type and call-to-party.
Clear Down	Push an Option key to terminate the phone call with an IP phone. ① Push before the target telephone is picked up, or during a phone call. ② The transceiver can terminate the phone call when a telephone calls the transceiver individually, or when the transceiver calls a telephone.
Mute	Hold down an Option key for 1 second to mute or unmute the received audio. ① The Notification beep will not be muted. ② You can also unmute the received audio by pushing [PTT].
Direct Dial	Push an Option key to display the Direct Dial screen. You can enter the destination ID or phone number by using Ten-key.
Emergency	Hold down an Option key until "Emergency" is displayed to send an Emergency call (p. 3-6).
Horn (Ext. I/O)	Push an Option key to turn the Horn function ON or OFF. ① An external horn is required.
ID List Select Mode (Ext. I/O)	Push an Option key to turn the External ID List Select function ON or OFF. When the function is ON, a call type and a destination ID or phone number is selected by only an external input operation. ① The function is usable when an external unit is connected to the transceiver.

Using a Bluetooth® device

You can connect to a Bluetooth device with built-in Bluetooth wireless technology.

① Only the VS-3 headset performance is guaranteed as of August 2019.

- The Bluetooth function may not be usable, depending on the presetting. Ask your dealer for details.
- The communication range of Bluetooth is approximately 10 m (33 ft).
 - ① May vary, depending on the environment in which the device operates.
- Although you can enter up to 6 Bluetooth devices in the transceiver device list, it is recommended that you pair only one device at a time.

Electromagnetic Interference

When you use a Bluetooth device, pay attention to the following: Bluetooth devices operate in the 2.4 GHz band that is also used by other appliances, such as Wireless LAN products, microwave ovens, RFID systems, amateur radio stations, and so on.

When using a Bluetooth device near such devices, interference may occur, causing a decrease in communication speed, and an unstable connection.

In such case, keep the Bluetooth devices away from the other appliances, or stop using those devices.

Bringing the Bluetooth device and the transceiver closer together also improves communication.

Bluetooth headset
(Example: Optional VS-3)

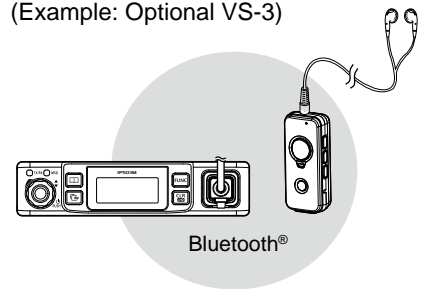

About the VS-3 Bluetooth headset

When you connect an optional VS-3 Bluetooth headset to the transceiver, you can wirelessly transmit and receive the headset audio.

The VS-3 has a [PTT] switch, so you can transmit in the same way as using the transceiver's [PTT] switch.

- The [FWD], [RWD], and [PLAY] keys on the VS-3 are disabled while using the headset with the IP501M.
- If the headset does not work correctly, even if the power is ON, push [RESET] with a pin to force power OFF.

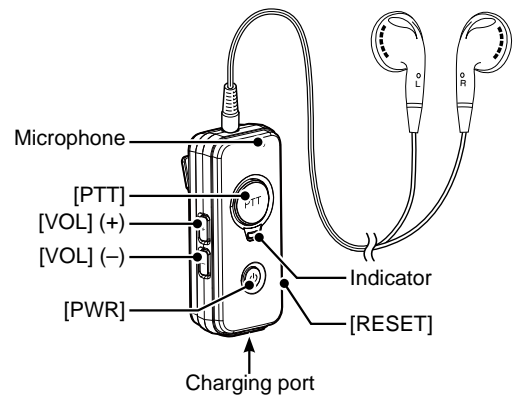

Function		Operation	Beep tone	Indicator
Bluetooth function	ON	Hold down [PWR] for 3 seconds	Melody (up)	Blinks blue
	OFF		Melody (down)	OFF
Pairing mode	Searching	While Bluetooth function is OFF, hold down [PWR] for 6 seconds	PiPa- (ready to connect)	Quickly blinks red then blue, every 3 seconds
	Connected		PiRo	Blinks blue twice, every 3 seconds
Transmit*1		Push [PTT]	Pi*2	Blinks red once, then blue twice, every 3 seconds
Audio volume	Up*1	Push [VOL] (+)	Pi	—
	Down*1	Push [VOL] (-)	Boo	—

*1: Functional only when a Bluetooth device is connected.

*2: Depends on the Notice Tone settings or "BT PTT Beep" setting in the Set mode.

Using the Bluetooth® device

■ Pairing with a Bluetooth device

This is an example of connecting the transceiver to a VS-3 Bluetooth headset.

1. Turning ON the transceiver's Bluetooth function

1. Hold down [FUNC] for 3 seconds to enter the Set mode.
2. Push [FUNC] or [Address] several times to select "Bluetooth."
3. Rotate [DIAL] to select "Enable," and then push [Call History] to turn ON the Bluetooth function.

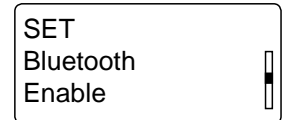

2. Entering the VS-3 Pairing mode

1. Confirm the VS-3 is turned OFF.
2. Hold down [PWR] for 6 seconds.
 - The indicator quickly blinks red then blue, and then the headset enters the Pairing mode.

NOTE:

- Charge the VS-3 before operating.
- The VS-3 starts up in the Pairing mode when its Bluetooth function is ON, but no bluetooth device is entered in its Pairing list.

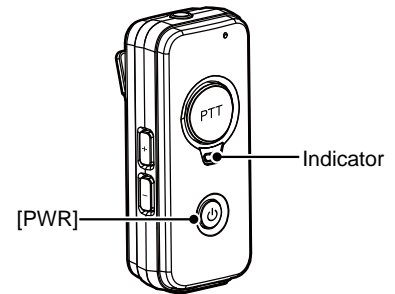

3. Pairing and connecting the Bluetooth device

1. On the transceiver, select "Search BT Device" in the Set mode, and then push [Call History].
 - The transceiver searches for a Bluetooth device.
 - ① Push [CLR/Lock] to cancel searching.
 - If found, the device's name and BD address are displayed on the screen. (Example: ICOM BT-002)
2. Rotate [DIAL] to select the headset to pair and connect, and then push [Call History].
 - "Connect" is displayed when the pairing has completed.
3. Push [CLR/Lock] to exit the Set mode and return to the Standby screen.
 - "☑" is displayed if the headset has correctly paired.

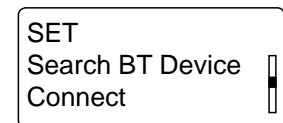
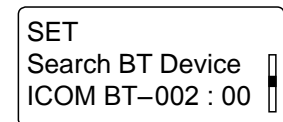

■ Settings for the Bluetooth function

You can customize the transceiver's Bluetooth settings in the Detailed Set mode. See the Set mode section for details.

Using the Bluetooth® device

■ Disconnecting a paired device

You can disconnect a paired Bluetooth device if it is not being used.

1. In the standby screen, push [FUNC] several times to select "Pairing List."
 2. Select the device to disconnect, and then push [Call History].
 - "Unconnected" is displayed if the headset or device is correctly disconnected.
- ① Do the same steps to reconnect to the Bluetooth device.

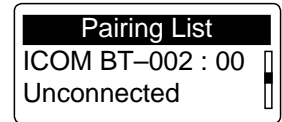

■ Deleting a device from the Pairing list

① Disconnect the headset before deleting it from the Pairing list.

1. In the Standby screen, hold down [FUNC] for 3 seconds to enter the Set mode.
2. Hold down [FUNC] for 3 seconds again to enter the Detailed Set mode.
 - "SET (Detail)" is displayed.
3. Push [FUNC] or [Address] to select "Delete BT Device" and then push [Call History].
 - The Bluetooth device is displayed.
4. Rotate [DIAL] to select the device that you want to delete, and then push [Call History].
 - "Delete?" is displayed.
5. Push [Call History] to delete the headset.
 - "Completed to delete" is displayed when the device has successfully been deleted.
6. Push [CLR/Lock] to return to the Standby screen.
 - "☞" disappears.

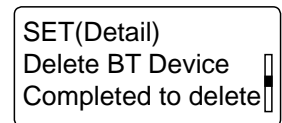
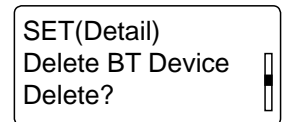

Using the Bluetooth® device

■ Initializing the Pairing lists

If you have problems with Bluetooth operation, initialize the pairing lists, as shown below.

Initializing the Pairing list of the transceiver

- ① All the paired Bluetooth devices are deleted from the Pairing list by the initialization.
- ① The Pairing list is not initialized by the RESET function in the Detailed Set mode.
- 1. In the Standby screen, hold down [FUNC] for 3 seconds to enter the Set mode.
- 2. Hold down [FUNC] for 3 seconds again to enter the Detailed Set mode.
- 3. Push [FUNC] or [Address] several times to select "Init BT Unit."
- 4. Rotate [DIAL] to select "YES."
 - ① To cancel the initialization, push any key other than [Call History].
- 5. Push [Call History].
 - The pairing list is initialized, and the transceiver automatically restarts.

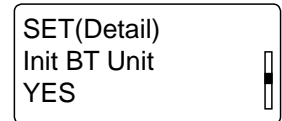

Initializing the Pairing list of the VS-3

- 1. Hold down [PWR] on the VS-3 for 3 seconds, to turn ON the Bluetooth function.
 - The indicator blinks blue.
- 2. Hold down [PWR] on the VS-3 for 3 seconds again, to turn OFF the Bluetooth function.
 - The indicator turns OFF.
- 3. Within 10 seconds, while holding down both [VOL] (+) and [VOL] (-), hold down [PWR] for 10 seconds.
 - The indicator lights violet, then turns OFF after the pairing list is initialized.

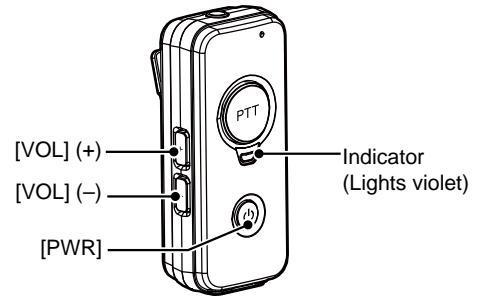

Troubleshooting	6-2
Specifications	6-3
◇ General	6-3
◇ LAN	6-3
◇ Audio.....	6-3
◇ 3G (W-CDMA).....	6-3
◇ LTE	6-3
◇ GNSS	6-4
◇ Bluetooth	6-4

Troubleshooting

The following conditions are not due to a malfunction. Check before sending a request for repair.

No power comes ON.

- Bad connection to the power supply.
 - Check the connection to the transceiver and power supply. (p. 1-3)
- Fuse is blown.
 - Find the cause, repair, and then replace the fuse.

The “” blinks, or “Connecting...” is displayed (standby screen is not displayed)

- The transceiver is located out of the service area.
 - Move your location.
 - Restart the transceiver.

No sound comes from the speaker.

- Volume level is set too low.
 - Rotate [DIAL] to adjust the volume level.



No beep sounds

- Key Beep Volume level is set too low.
 - Set the volume to a suitable level in the Set mode. (p.4-4)

Calls cannot be made

- The call-to party number or group number is wrong.
 - Check the call-to party number or group number.

No reply is received.

- The transceiver is located out of the service area. (“” blinks.)
 - Move your location, and then try again.
- The transceiver is not registered to the system. (“” is displayed.)
 - Push [PTT] to re-register the transceiver to the system.
 - Wait for a while, or change your location.
 - Check that the LTE line is established.
- The operator is away from the transceiver, or the transceiver is turned OFF.
 - Wait until the operator is back, or ask your system manager.

“Key lock” is displayed when you push any keys

- The keys are locked.
 - Hold down [CLR/Lock] to unlock.

Failed to pair your Bluetooth headset

- The Bluetooth headset is not in the Pairing mode.
 - Confirm the Bluetooth headset is in the Pairing mode, and then try again. (p. 5-6)
- There are other active Bluetooth devices nearby.
 - Stop using other Bluetooth devices.
 - Use the transceiver away from other Bluetooth devices.
- There are other devices that are operating in the 2.4 GHz band.
 - Use the transceiver away from the other devices, or stop using those devices.

No position data is received.

- The GPS antenna cannot receive the GPS signals from satellites. (“” blinks.)
 - Relocate the antenna to the place without obstructions.

Specifications

① Measurements made without an antenna.

① All stated specifications are subject to change without notice or obligation.

◇ General

Power supply	DC 13.8 V \pm 10%/DC 26.4 V \pm 10%	
Current drain	1.2 A maximum (DC 13.8 V), 0.8 A maximum (DC 26.4 V)	
Operating environment	Temperature	-10°C ~ +60°C, 14°F ~ 140°F
	Humidity	25 ~ 85% (Without condensation)
Dimensions (Projections not included)	125 (W) \times 29 (D) \times 156 (H) mm, 4.9 (W) \times 1.1 (D) \times 6.1 (H) in	
Weight	Approximately 840 g, 1.9 lb (Without microphone)	
Regulatory Compliance	USA version	FCC Part 15 Class B/ICES-003, Part 15C, Part 22, Part 24, Part 27
	European version	EN300 328, EN301 489-1, EN301 489-17, EN301 489-19, EN301 489-52, EN301 908-1, EN301 908-2, EN301 908-13, EN303 413, EN55032, EN 55024, EN62311, EN62368-1
	Australian version	AS/NZS Standard
Interface	Indicator (TX/RX, MSG) Operating keys ([Address], [FUNC], [Call History], [CLR/Lock]) [LAN] port, [Microphone] jack Antenna connectors (LTE antenna \times 2, GPS antenna \times 1) [EXT I/O] port (For optional OPC-2407 D-sub 25 pin cable) External speaker jack (ϕ 3.5 mm)	
IP code	IP54 (Only when the microphone is attached)	

◇ LAN

Communication rate	10/100 Mbps (Automatic switching/Full duplex)
Interface	[LAN] port (RJ-45 type) \times 1 (Auto MDI/MDI-X) • IEEE802.3/10BASE-T • IEEE802.3u/100BASE-TX

◇ Audio

Codec	G.726
AF output power	More than 4 W (External speaker, 4 Ω , 10% distortion)
Microphone impedance	600 Ω
AF output impedance	4 Ω (External speaker)

◇ 3G (W-CDMA)

Frequency band	USA version	B2, B5
	European version	B1, B8
	Australian version	B1, B5
Transmission power	24 dBm (Typical)	

◇ 4G (LTE)

Frequency band	USA version	B2, B4, B12
	European version	B1, B3, B7, B8, B20
	Australian version	B1, B3, B5, B7, B8, B28
Transmission power	23 dBm (Typical)	

Specifications**◇ GNSS**

GPS	1575.42 MHz \pm 1.023 MHz
GLONASS	1597.5 ~ 1605.8 MHz

◇ Bluetooth

Frequency range	2402 ~ 2480 MHz
Transmission power	Conducted 4.5 dBm
Version	Bluetooth Version 2.1+EDR
Profile	HFP, HSP, SPP

Count on us!

