



INSTRUCTION MANUAL

VHF DIGITAL TRANSCEIVER

IC-F5220D

UHF DIGITAL TRANSCEIVER

IC-F6220D



Icom Inc.

IMPORTANT

READ ALL INSTRUCTIONS carefully and completely before using the transceiver.

SAVE THIS INSTRUCTION MANUAL — This instruction manual contains important operating instructions for the **IC-F5220D VHF DIGITAL TRANSCEIVER** and the **IC-F6220D UHF DIGITAL TRANSCEIVER**.

 See the operating guide for details of IDAS (ICOM Digital Advanced System) system operations. Ask your dealer for details.

EXPLICIT DEFINITIONS

WORD	DEFINITION
 WARNING!	Personal injury, fire hazard or electric shock may occur.
CAUTION	Equipment damage may occur.
NOTE	If disregarded, inconvenience only. No risk of personal injury, fire or electric shock.

FCC INFORMATION

• **FOR CLASS A UNINTENTIONAL RADIATORS:**

This equipment has been tested and found to comply with the limits for a Class A digital device, pursuant to part 15 of the FCC Rules. These limits are designed to provide reasonable protection against harmful interference when the equipment is operated in a commercial environment. This equipment generates, uses, and can radiate radio frequency energy and, if not installed and used in accordance with the instruction manual, may cause harmful interference to radio communications.

Operation of this equipment in a residential area is likely to cause harmful interference in which case the user will be required to correct the interference at his own expense.

CAUTION: Changes or modifications to this transceiver, not expressly approved by Icom Inc., could void your authority to operate this transceiver under FCC regulations.

PRECAUTIONS

⚠ **WARNING! NEVER** connect the transceiver to an AC outlet. This may pose a fire hazard or result in an electric shock.

⚠ **WARNING! NEVER** connect the transceiver to a power source of more than 16 V DC or use reverse polarity. This could cause a fire or damage the transceiver.

⚠ **WARNING! NEVER** cut the DC power cable between the DC plug and fuse holder. If an incorrect connection is made after cutting, the transceiver might be damaged.

⚠ **WARNING! NEVER** place the transceiver where normal operation of the vehicle may be hindered or where it could cause bodily injury.

CAUTION: NEVER allow children to touch the transceiver.

CAUTION: NEVER expose the transceiver to rain, snow or any liquids.

USE the specified microphone only. Other microphones have different pin assignments and may damage the transceiver.

DO NOT use or place the transceiver in areas with temperatures below -30°C (-22°F) or above $+60^{\circ}\text{C}$ ($+140^{\circ}\text{F}$), or in areas subject to direct sunlight, such as the dashboard.

DO NOT operate the transceiver without running the vehicle's engine. The vehicle's battery will quickly run out when the transceiver transmits while the vehicle's engine is OFF.

DO NOT place the transceiver in excessively dusty environments.

DO NOT place the transceiver against walls. This will obstruct heat dissipation.

DO NOT use harsh solvents such as benzine or alcohol when cleaning, as they will damage the transceiver surfaces.

BE CAREFUL! The transceiver will become hot when operating continuously for long periods of time.

Icom, Icom Inc. and the Icom logo are registered trademarks of Icom Incorporated (Japan) in Japan, the United States, the United Kingdom, Germany, France, Spain, Russia and/or other countries. All other products or brands are registered trademarks or trademarks of their respective holders.

VOICE CODING TECHNOLOGY

The AMBE+2™ voice coding Technology embodied in this product is protected by intellectual property rights including patent rights, copyrights and trade secrets of Digital Voice Systems, Inc. This voice coding Technology is licensed solely for use within this Communications Equipment. The user of this Technology is explicitly prohibited from attempting to extract, remove, decompile, reverse engineer, or disassemble the Object Code, or in any other way convert the Object Code into a human-readable form. U.S. Patent Nos.

#5,870,405, #5,826,222, #5,754,974, #5,701,390, #5,715,365, #5,649,050, #5,630,011, #5,581,656, #5,517,511, #5,491,772, #5,247,579, #5,226,084 and #5,195,166.

TABLE OF CONTENTS

IMPORTANT.....	i
EXPLICIT DEFINITIONS.....	i
FCC INFORMATION	i
PRECAUTIONS.....	ii
VOICE CODING TECHNOLOGY	iii
TABLE OF CONTENTS.....	iii
1 PANEL DESCRIPTION.....	1-5
■ Front panel.....	1
■ Function display	2
■ Programmable function keys.....	3
2 BASIC OPERATION.....	6-8
■ Turning ON the power	6
■ Channel selection	6
■ Receiving and transmitting.....	7
■ User Set mode	8
■ Priority A channel selection.....	8
3 CONNECTION AND MAINTENANCE	9-12
■ Rear panel connection	9
■ Supplied Accessories.....	10
■ Mounting the transceiver.....	10
■ Antenna.....	11
■ Fuse replacement	11
■ Cleaning.....	11
■ Options.....	12
4 SAFETY TRAINING INFORMATION.....	13-14

■ Front panel

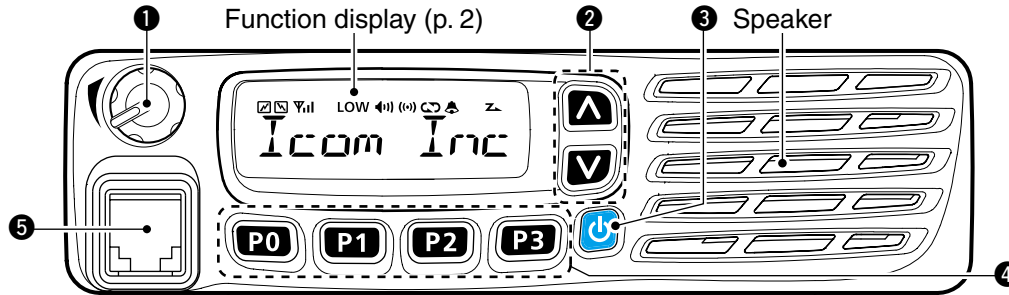

1 AF VOLUME CONTROL KNOB [VOL]

- Rotate the knob to adjust the audio output level.
- Minimum audio level is preprogrammed. (p. 8)

2 UP/DOWN KEYS [UP]/[DOWN]

- Push to select an operating channel and so on.
- * The desired function can be assigned by your dealer. (p. 3)

3 POWER KEY [⏻]

- Push to turn the power ON or OFF.
- The following optional functions are available at power ON:
 - Automatic scan start
 - Password prompt

4 DEALER-PROGRAMMABLE KEYS

- Required functions can be independently programmed by your dealer. (p. 3)

5 MICROPHONE CONNECTOR

- Connect the supplied or optional microphone. See page 10 for detail of the PTT switch and a hanger hook operations.

NEVER connect non-specified microphones. The pin assignments may be different and may damage the transceiver.

1 PANEL DESCRIPTION

■ Function display

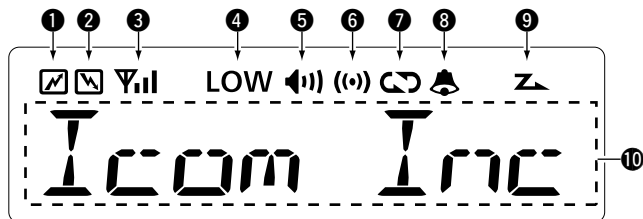

1 TRANSMIT ICON

Appears while transmitting a signal.

2 BUSY ICON

Appears while the channel is busy (receiving).

3 SIGNAL STRENGTH ICON

Shows the relative receive signal strength level.



Weak ← Receive Signal level ⇒ Strong

About “▽” icon for the Trunking mode

- Disappears while in the no service area.
- Blinks while registering to the repeater.
- Appears when the registration is completed.

4 LOW POWER ICON

Appears when low output power is selected.

5 AUDIBLE ICON

- In the analog mode, appears when the CTCSS (DTCS) squelch mute is released while holding down [Monitor].
- In the digital mode, appears while holding down [Monitor].

6 GPS ICON

Appears when the GPS receiver acquires the received GPS signal from a satellite.

7 ENCRYPTION ICON

In the digital mode, appears when the encryption function is activated.

8 BELL ICON

In the digital mode, appears/blinks when a SDM (Short Data Message), Status Call or Call Alert is received, depending on the preprogramming.

9 SCAN ICON

- Blinks during a scan.
- Appears when a scan channel is selected.

10 ALPHANUMERIC DISPLAY

Displays an operating channel number, channel name, User Set mode contents, and so on.

■ Programmable function keys

The following functions can be assigned to [UP], [DOWN], [P0], [P1], [P2] and [P3] programmable function keys.

Consult your Icom dealer or system operator for details concerning your transceivers programming.

/// **NOTE:** The function keys for the digital mode are described in the operating guide.

CH UP AND DOWN

As described in the following topics, after pushing a programmed key, push [CH Up] or [CH Down] to select an option, setting, and so on.

ZONE

Push this key, then select the desired zone using [CH Up]/[CH Down].

/// **What is “zone”?**— Certain channels are grouped together and assigned to a zone, according to their intended use. For example, ‘Staff A’ and ‘Staff B’ are assigned to a “Business” zone, and ‘John’ and ‘Cindy’ are assigned to a “Private” zone.

SCAN START/STOP

- Push to start and cancel a scan.
 - When a scan is started with the Power ON Scan or Automatic scan function, push this key to cancel it. The cancelled scan resumes after the preprogrammed time period.
- Hold down this key for 1 second to display the scan group, then push [CH Up] or [CH Down] to select the desired one.

SCAN ADD/DEL (TAG)

- Push to add the channel to, or delete it from, the current scan group.
 1. Hold down to display the scan group, then push [CH Up] or [CH Down] to select the desired one.
 2. Push to add the channel to, or delete it from, the selected scan group.
 3. Hold down for 1 second to exit the scan list selection mode.
- While a scan is paused on a non-priority channel, push this key to delete the selected channel from the scan group.
 - /// Depending on the setting, the cleared channel is added to the scan group again after the scan is cancelled.

1 PANEL DESCRIPTION

■ Programmable function keys (Continued)

PRIORITY A CHANNEL, PRIORITY B CHANNEL

Push to select the Priority A or Priority B channel.

PRIORITY A CHANNEL (REWRITE),

PRIORITY B CHANNEL (REWRITE)

- ➔ Push to select the Priority A or Priority B channel.
- ➔ Hold down [Prio A (Rewrite)] or [Prio B (Rewrite)] for 1 second to assign the operating channel to Priority A or Priority B channel, respectively.

MEMORY CHANNELS 1, 2, 3, 4

Push to directly select memory channel 1, 2, 3 or 4, if programmed.

Consult your dealer for details.

MONITOR

Push to turn the CTCSS (DTCS) squelch mute ON or OFF.

LIGHT

Push to turn ON the backlight for about 5 seconds, when the backlight function is set to "OFF" in the User Set mode.

HIGH/LOW

Push to select the transmit output power temporarily or permanently, depending on the preprogramming.

- Ask your dealer for the output power level for each selection.

LOCK

- ➔ Hold down this key until "LOCK ON" is displayed to electronically lock all programmable keys except the following: [Moni], [Lock], [Emergency]*, [Power OFF Emergency]*, [Surveillance], [Siren], [Lone Worker]*, [Light] and [Shift].
*For digital operation. See the operating guide for details
- ➔ To turn OFF the Key Lock function, hold down this key until "LOCK OFF" is displayed.

TALK AROUND

Push to turn the Talk Around function ON or OFF.

- The Talk Around function equalizes the transmit frequency to the receive frequency for transceiver-to-transceiver communication.

WIDE/NARROW

Push to toggle the IF bandwidth between wide and narrow.

SURVEILLANCE

Push to turn the surveillance function ON or OFF.

When this function is turned ON and a signal is received, the beep is not heard and the LED does not light, even if a key is pushed.

SIREN

Hold down for 1 second to sound the siren.

This function can be used for situations other than an emergency alert, such as a security alarm for example.

- The siren can only be stopped by turning OFF the transceiver power.

HOOK SCAN

When the Hook Scan function is preprogrammed, push this key to temporarily disable the function. Push this key again to enable the function.

USER SET MODE

- Hold down for 1 second to enter the User Set mode.
 - While in the User Set mode, push this key to select an item*, and change the value or setting using [CH Up] or [CH Down].
*Selectable items may differ, depending on the preprogramming.
- Hold down this key for 1 second again to exit the User Set mode.

EXT. CH SEL MODE

- Push to turn the Ext. CH Select function ON or OFF. When the function is turned ON, memory channels can be selected with only an external input. When the function is turned OFF, memory channels can be selected by pushing [CH Up] or [CH Down], and cannot be externally controlled.
- This function is usable when an external unit, such as a dimmer control is connected to the transceiver with an optional OPC-1939 or OPC-2078 cable (p. 12).
 - Ask your dealer for more details on external input operation.

ANNOUNCE

Push to turn the Channel Announce function ON or OFF. When this function is turned ON, the transceiver announces the channel number when it is selected.

RESET

- Push to return to the normal operating mode.
- While in the audible mode, push to return to the inaudible mode.

/// **NOTE:** See the operating guide for the [Reset] key operations in the digital mode.

GPS DISPLAY

Push to switch the display mode between stand-by and GPS position data.

SHIFT

- Push to switch the Normal mode key functions and the Shift mode key functions.
- When the Shift mode is selected, the display briefly shows “SHIFT ON.” When the Normal mode is selected, the display briefly shows “SHIFT OFF.”

■ Turning ON the power

- ① Push [⏻] to turn ON the power.
- ② If the transceiver is programmed for a start up password, input the digit codes that were set by your dealer.
 - The keys shown below can be used for password input:
The transceiver detects numbers in the same block as identical. Therefore “01234” and “56789” are the same.

KEY	P0	P1	P2	P3	V
NUMBER	0	1	2	3	4
	5	6	7	8	9

- ③ If the “PASSWORD” indication does not clear after inputting 6 digits, the input code number may be incorrect. Turn OFF the power and re-enter your password.

■ Channel selection

There are several ways to select channels, and they may differ, depending on your system set up.

NON-ZONE TYPE:

To select the desired operating channel:

- Push [CH Up] or [CH Down].
- Push one of [MR-CH 1] to [MR-CH 4].

ZONE TYPE:

To select the desired operating channel:

- Push [Zone], then push [CH Up] or [CH Down].

VOTING OPERATION:

The transceiver automatically starts scanning when a zone, specified for the voting operation, is selected.

The voting scan detects the S-meter of the repeater and automatically selects the strongest station.

AUTOMATIC SCAN TYPE:

Channel setting is not necessary for this type. When turning ON the power, the transceiver automatically starts scanning. Scanning stops when a signal is detected.

■ Receiving and transmitting

Receiving:

- ① Hold down [⏻] for 1 second to turn ON the power.
- ② Push [CH Up] or [CH Down] to select a channel.
- ③ When receiving a call, rotate [VOL] to adjust the audio output level to a comfortable listening level.

Transmitting:

Wait for the channel to become clear to avoid interference.

- ① Take the microphone OFF hook.
 - The 'Audible' mode is selected.
 - A priority channel may be automatically selected.
- ② Wait for the channel to become clear.
 - The channel is busy when the BUSY icon appears on the LCD.
- ③ While holding down [PTT], speak into the microphone at your normal voice level.
- ④ Release [PTT] to return to receive.

-  **IMPORTANT:** To maximize the readability of your signal;
1. Pause briefly after pushing [PTT].
 2. Hold the microphone 5 to 10 cm (2 to 4 inches) from your mouth, then speak into the microphone at a normal voice level.

◇ **Transmitting notes**

• **Transmit inhibit function**

The transceiver has several inhibit functions which restrict transmission under the following conditions:

- The channel is busy. However, depending on the preprogrammed settings, you can transmit when the call includes an unmatching (or matching) CTCSS (DTCS), RAN code*, or Individual or Talk-group ID*.

* Digital operation only

- The selected channel is a 'receive only' channel.

• **Time-out timer**

If continuous transmission exceeds the preprogrammed time-out timer limit, the transmission is cut off.

• **Penalty timer**

After the transmission is cut off by the time-out timer, transmission is further inhibited for the preprogrammed penalty timer period.

2 BASIC OPERATION

■ User Set mode

The User Set mode allows you to set seldom-changed settings. If the transceiver has [User Set Mode] assigned to it, you can “customize” the transceiver operation to suit your preferences and operating style.

Entering the User Set mode:

- ① Hold down [User Set Mode] for 1 second to enter the User Set mode.
- ② Push [User Set Mode] several times to select the appropriate item. Then push [CH Up] or [CH Down] to set the desired level/condition.
 - Selectable Set mode items are **Backlight, Beep ON/OFF, Beep Level, Ringer Level, SQL Level, AF Min Level, Mic Gain, Horn, Battery Voltage, Signal Moni, Lone Worker** and **System Info**.
- ③ Hold down [User Set Mode] for 1 second again to exit the User Set mode.

■ Priority A channel selection

When one of the following operations is performed, the transceiver automatically selects the Priority A channel.

- **Turning ON the power**
The Priority A channel is selected each time the transceiver power is turned ON.
- **Auto Reset**
The Priority A channel is selected when the Auto Reset timer ends.
- **OFF hook**
The Priority A channel is selected when you take the microphone OFF hook.

Rear panel connection

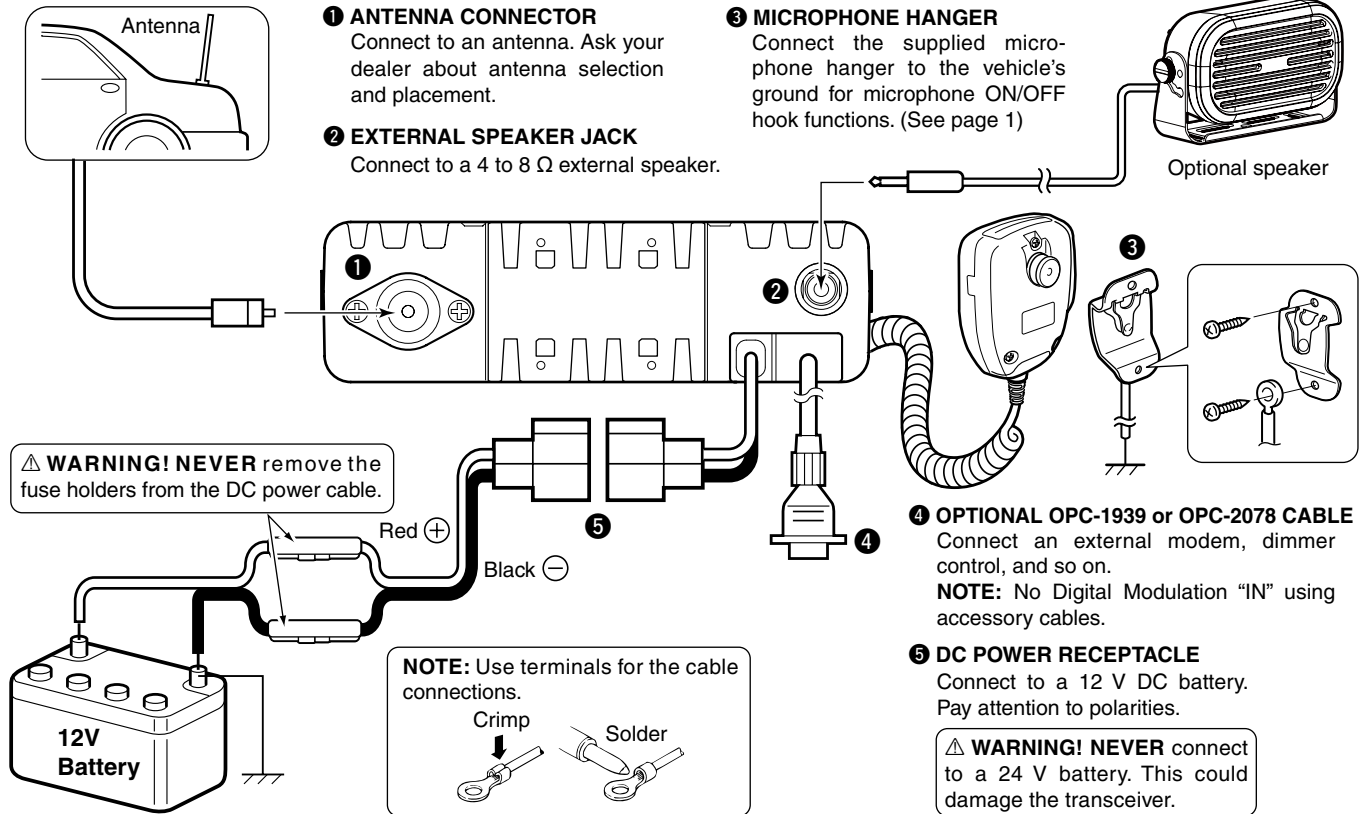

2
3

3 CONNECTION AND MAINTENANCE

■ Supplied Accessories

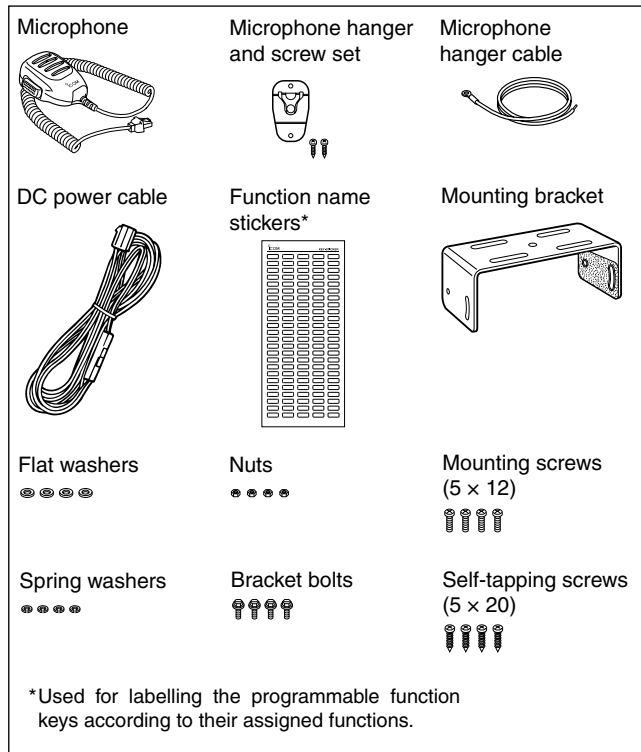

◇ Microphone

The supplied or optional microphone has a PTT switch and a hanger hook.

- The following functions are available when the microphone is ON or OFF hook (depending on the preprogramming):
 - Automatic scan starts when you put it ON hook.
 - Scan is cancelled when you take it OFF hook.
 - Scan is paused when you take it OFF hook.
 - Automatically selects the Priority channel when you take it OFF hook.
 - Sets to the 'Inaudible' mode (mute state) when you put it ON hook.
 - Sets to the 'Audible' mode (unmute state) when you take it OFF hook.

■ Mounting the transceiver

The universal mounting bracket supplied with your transceiver allows overhead mounting.

- Mount the transceiver securely with the 4 supplied screws to a thick surface which can support more than 1.5 kg (3.3 lb).

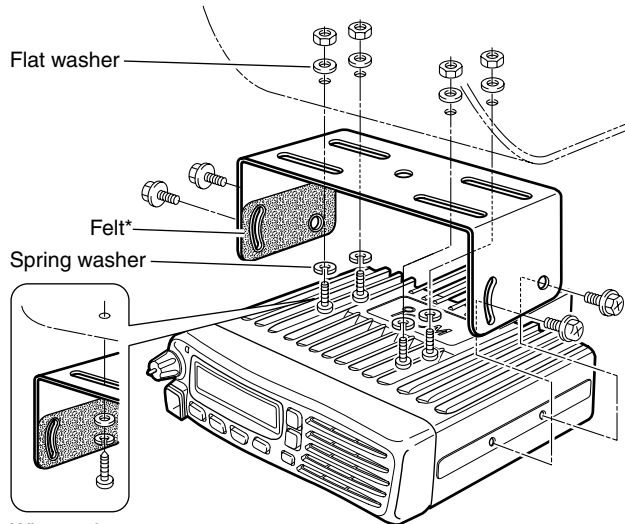

When using self-tapping screws

*Felt reduces the effects of vibration.

■ Antenna

A key element in the performance of any communication systems is its antenna. Contact your dealer for more information regarding antennas and how to install them.

■ Fuse replacement

A fuse is installed in each fuse holder of the supplied DC power cable. If a fuse blows or the transceiver stops functioning, track down the source of the problem if possible, repair it and then replace the damaged fuse with a new rated one.

- Fuse rating: 20 A

USE only the applicable fuse.

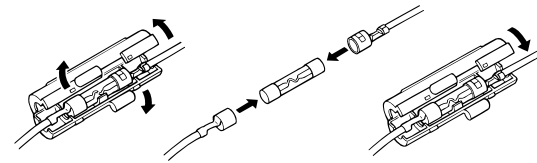

3 CONNECTION AND MAINTENANCE

■ Cleaning



If the transceiver becomes dusty or dirty, wipe it clean with a soft, dry cloth.

DO NOT use harsh solvents such as benzine or alcohol, as they will damage the transceiver surfaces.

■ Options

- **OPC-1132A/OPC-347** DC POWER CABLE
Two fuse holders are attached. **USE** only the 20 A fuse.
OPC-1132A: 3 m (9.8 ft)
OPC-347: 7 m (23 ft)
- **OPC-1939/OPC-2078** ACC CABLE
Allows you to connect to an external terminal.
OPC-1939: D-sub 15-pin, OPC-2078: D-sub 25-pin
NOTE: No Digital Modulation "IN" using accessory cables.
- **HM-152/HM-148G** HAND MICROPHONE
HM-152: Hand microphone
HM-148G: Self ground heavy duty microphone
- **SM-26** DESKTOP MICROPHONE
- **SP-30/SP-35** EXTERNAL SPEAKER
Input impedance: 4 Ω
Max. input power: 30 W (SP-30)/7 W (SP-35)
SP-30: High input power level.
SP-35: Compact and easy-to-install.

Approved Icom optional equipment is designed for optimal performance when used with an Icom transceiver. Icom is not responsible for the destruction or damage to an Icom transceiver in the event the Icom transceiver is used with equipment that is not manufactured or approved by Icom.



Your Icom radio generates RF electromagnetic energy during transmit mode. This radio is designed for and classified as “Occupational Use Only”, meaning it must be used only during the course of employment by individuals aware of the hazards, and the ways to minimize such hazards. This radio is NOT intended for use by the “General Population” in an uncontrolled environment.

- For compliance with FCC and Industry Canada RF Exposure Requirements, the transmitter antenna installation shall comply with the following two conditions:

1. The transmitter antenna gain shall not exceed 0 dBi.
2. IC-F5220D:

The antenna is required to be located outside of a vehicle and kept at a distance of 45 centimeters or more between the transmitting antenna of this device and any persons during operation. For small vehicle as worst case, the antenna shall be located on the roof top at any place on the centre line along the vehicle in order to achieve 45 centimeters separation distance. In order to ensure this distance is met, the installation of the antenna must be mounted at least 45 centimeters away from the nearest edge of the vehicle in order to protect against exposure to bystanders.

2. IC-F6220D:

The antenna is required to be located outside of a vehicle and kept at a distance of 37 centimeters or more between the transmitting antenna of this device and any persons during operation. For small vehicle as worst case, the antenna shall be located on the roof top at any place on the centre line along the vehicle in order to achieve 37 centimeters separation distance. In order to ensure this distance is met, the installation of the antenna must be mounted at least 37 centimeters away from the nearest edge of the vehicle in order to protect against exposure to bystanders.

3. IC-F5220D:

Transmit only when people outside the vehicle are at least the recommended minimum distance of 100 centimeters away from the properly installed antenna. This separation distance will ensure that there is sufficient distance from a properly installed externally-mounted antenna to satisfy the RF exposure requirements in the applicable RF exposure compliance standards.

3. IC-F6220D:

Transmit only when people outside the vehicle are at least the recommended minimum distance of 82 centimeters away from the properly installed antenna. This separation distance will ensure that there is sufficient distance from a properly installed externally-mounted antenna to satisfy the RF exposure requirements in the applicable RF exposure compliance standards.

4 SAFETY TRAINING INFORMATION



CAUTION

To ensure that your exposure to RF electromagnetic energy is within the FCC allowable limits for occupational use, always adhere to the following guidelines:

- **DO NOT** operate the radio without a proper antenna attached, as this may damage the radio and may also cause you to exceed FCC RF exposure limits. A proper antenna is the antenna supplied with this radio by the manufacturer or an antenna specifically authorized by the manufacturer for use with this radio.
- **DO NOT** transmit for more than 50% of total radio use time (“50% duty cycle”). Transmitting more than 50% of the time can cause FCC RF exposure compliance requirements to be exceeded. The radio is transmitting when the “transmit indicator” appears on the LCD. You can cause the radio to transmit by pressing the “PTT” switch.

Electromagnetic Interference/Compatibility

During transmissions, your Icom radio generates RF energy that can possibly cause interference with other devices or systems. To avoid such interference, turn OFF the radio in areas where signs are posted to do so. **DO NOT** operate the transmitter in areas that are sensitive to electromagnetic radiation such as hospitals, aircraft, and blasting sites.

Count on us!

A-7079H-1EX-①
Printed in Japan
© 2013 Icom Inc.

Printed on recycled paper with soy ink.

Icom Inc.

1-1-32 Kamiminami, Hirano-ku, Osaka 547-0003, Japan