



Version 1.0  
June 2023

# IC-F200

## *PRODUCT GUIDE*





## PREFACE

This product guide is made to promote our new product, the IC-F200 transceiver. The new product's outline and specifications are described in this document, and you will understand the target users, built-in functions, and sales points of this transceiver.

This product guide's target users are dealer sales staff members who are going to sell this transceiver for the first time and have already sold Icom analog mode products.

Icom hopes this product guide will help you to promote sales of the IC-F200 transceiver.

### **Trademarks**

Icom and the Icom logo are registered trademarks of Icom Incorporated (Japan) in Japan, the United States, the United Kingdom, Germany, France, Spain, Russia, Australia, New Zealand, and/or other countries.

USB TYPE-C is a trademark of USB Implementers Forum Inc.

All other trademarks are the properties of their respective holders.

© 2023 Icom Inc.

# TABLE OF CONTENTS

<b>SECTION 1</b>	<b>PRODUCT OUTLINE .....</b>	<b>4</b>
	1-1 ABOUT THE IC-F200 TRANSCEIVER .....	4
	1-2 SELLING POINTS .....	5
	1-3 PANEL DESCRIPTION .....	8
	1-4 FUNCTION DISPLAY DESCRIPTION .....	9
	1-5 DIMENSIONS .....	10
	1-6 TARGET USERS .....	11
<b>SECTION 2</b>	<b>PRODUCT RANGE .....</b>	<b>12</b>
<b>SECTION 3</b>	<b>COMPARISON WITH OTHER ICOM MODELS .....</b>	<b>13</b>
	3-1 FUNCTION COMPARISON .....	13
	3-2 SPECIFICATION COMPARISON BETWEEN THE USA VERSION .....	14
	3-3 SPECIFICATION COMPARISON BETWEEN THE EXP VERSION .....	15
<b>SECTION 4</b>	<b>COMPARISON TO COMPETITORS .....</b>	<b>17</b>
	4-1 FUNCTION COMPARISON .....	17
	4-2 SPECIFICATION COMPARISON .....	18
<b>SECTION 5</b>	<b>MAJOR FUNCTION INTRODUCTION .....</b>	<b>19</b>
	5-1 EMERGENCY CALL .....	19
	5-2 AIR CLONE FUNCTION (FOR ONLY EXP VERSION) .....	20
<b>SECTION 6</b>	<b>OPTIONAL ACCESSORIES .....</b>	<b>21</b>

## SECTION 1 PRODUCT OUTLINE

### 1-1 ABOUT THE IC-F200 TRANSCEIVER

The IC-F200 transceiver is a UHF land mobile transceiver. This model is designed assuming light mission users use it for short-range communication. This model has been made to be rugged even for this class of products and carefully selected operation modes and functions.

This transceiver is useful for various situations, for example in restaurant and warehouse, with closing distance communication.

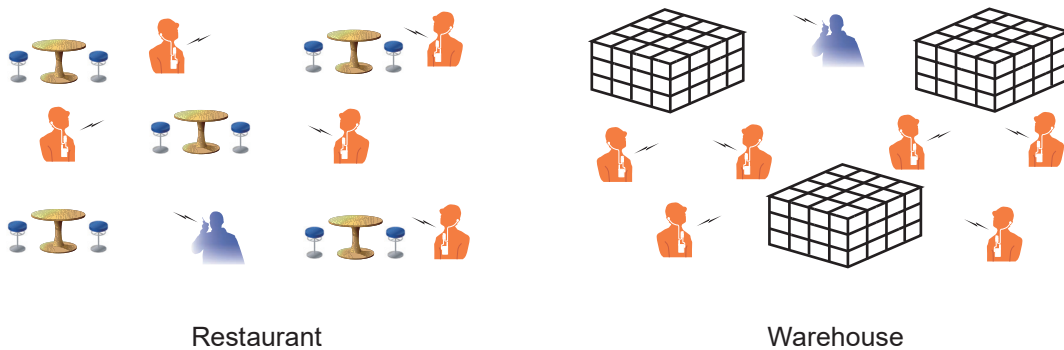

The fixed antenna on the IC-F200 is designed at the optimum length for good communication performance and to be easy to carry. The antenna is fixed on the transceiver, and users cannot remove or exchange it.

The antenna is fixed on the transceiver.





## 1-2 SELLING POINTS

### • SMALL SIZE AND LIGHT WEIGHT

The IC-F200 is designed to be lighter in weight and smaller than the existing IC-F2000 and IC-F4000 series transceivers. Therefore, users can easily carry this transceiver by attaching it to the body with the belt clip.

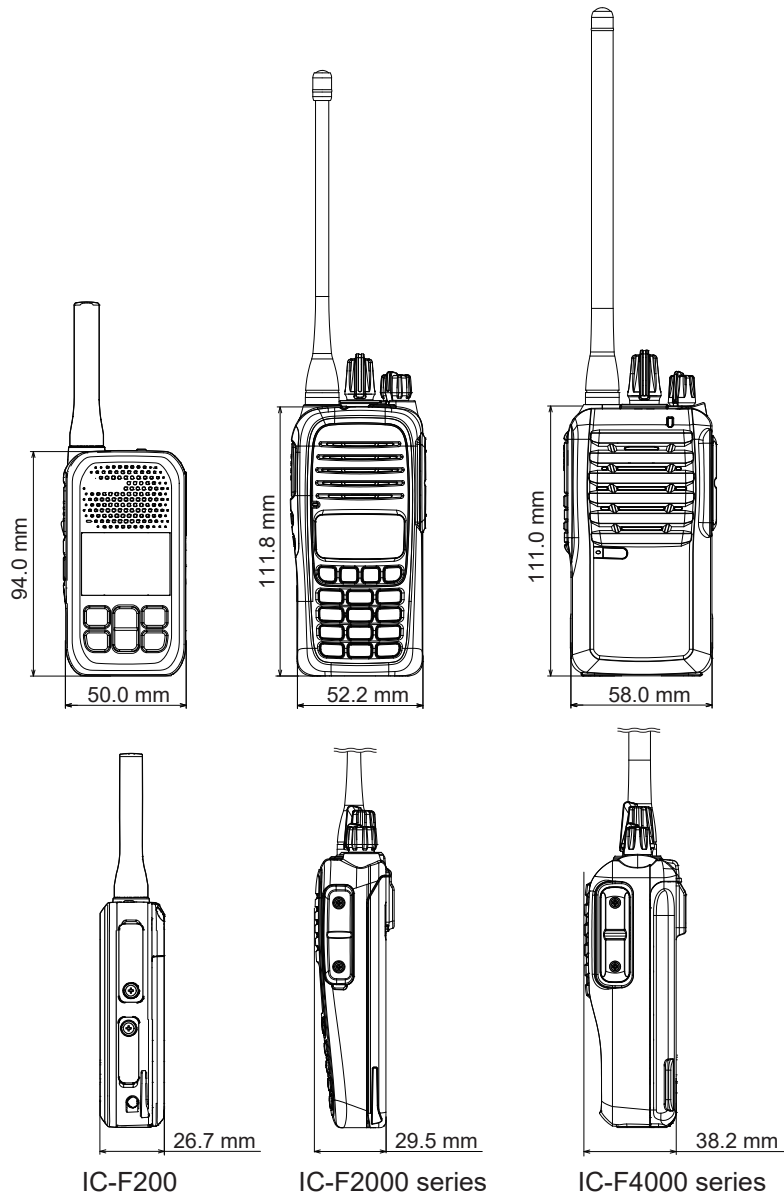

### The IC-F200's comparisons of size volume and weight

Comparison model	IC-F200 Size (H: 94.0 × W: 50.0 × D: 26.7 mm) Weight (157 g with BP-304A)	
	Size volume ratio	Weight ratio
<b>IC-F2000 series</b> Size (H: 111.8 × W: 52.2 × D: 29.5 mm) Weight (230 g with BP-278)	73%	68%
<b>IC-F4000 series</b> Size (H: 111.0 × W: 58.0 × D: 38.2 mm) Weight (330 g with BP-264)	51%	49%

**• EASY OPERATION**

The IC-F200 has 6 keys on the front panel, and 1 each on the top and side panels. Only one function is assigned to all keys except [CH/SET]. So, users can easily to operate the IC-F200.

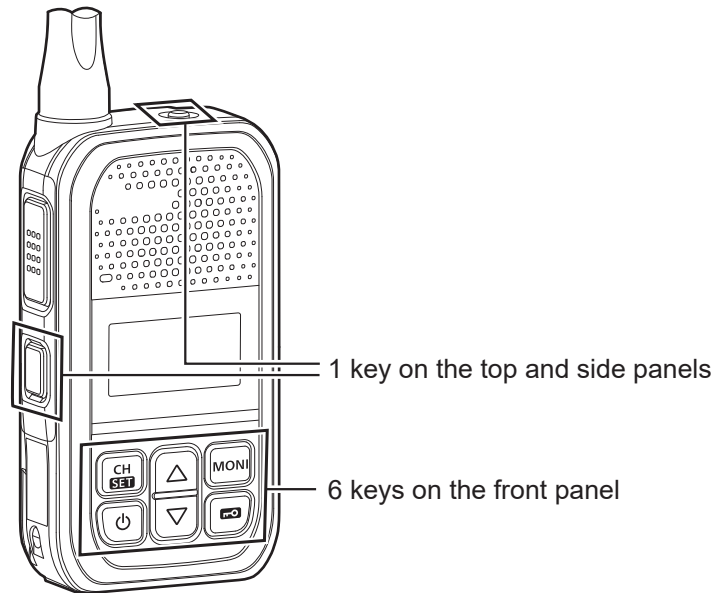

**• IP54 CONSTRUCTION**

The IC-F200 is compatible with IP54. Therefore, this transceiver can be used outside.

**• A USB PORT**

Charging the installed battery pack is done with the supplied power adapter and a USB charger in the market. The charging period may differ, depending on the charging current of the connected charging device.

**NOTE:** The USB port is only for battery charging, not for data communication.

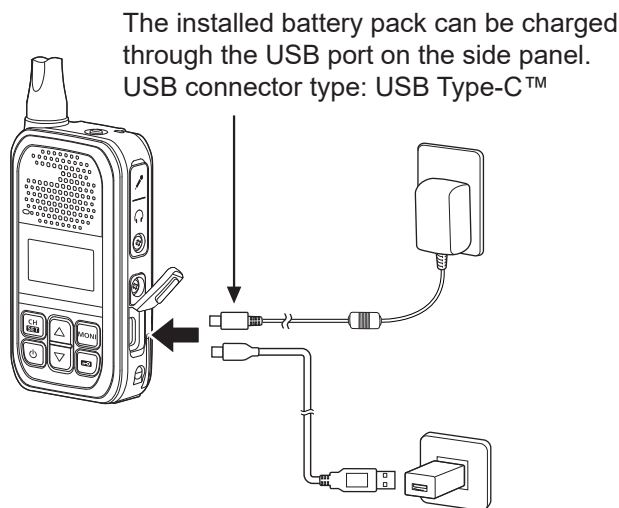

• The charging period is approximately 5.5 hours.

**• PROGRAMMABLE KEYS MOUNTED**

The IC-F200 has 2 programmable keys on the top and side panels. One of the emergency functions, transmitting power selection, Scan Start/Stop, or Surveillance function can be assigned to the keys.

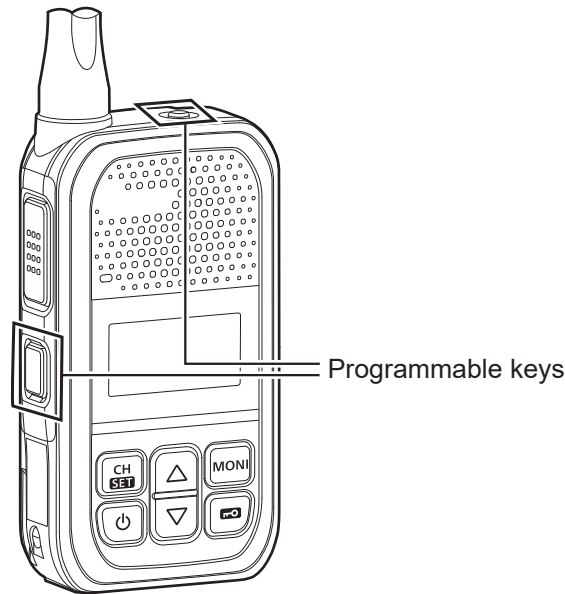

**• HIGH AUDIO OUTPUT POWER**

A 28 mm (1.1 inches) diameter speaker is installed. The speaker provides 0.5 W high audio output, even in the small body. Speaker sound pressure level: 83 dB  $\pm$ 3 dB (1 W/0.5 m at 1 kHz)

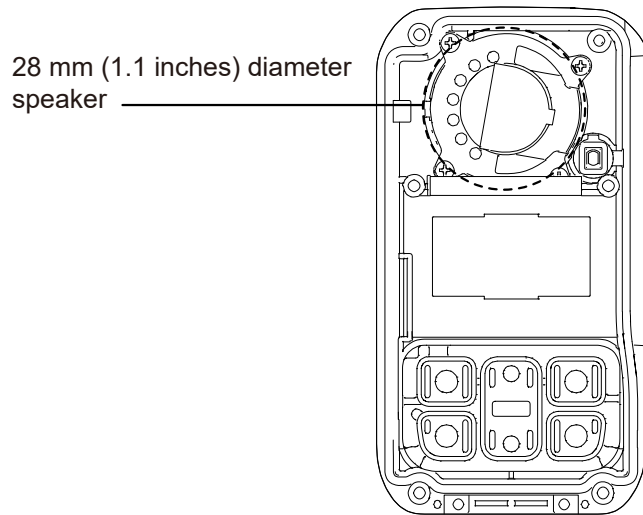

FRONT panel back view

1-3 PANEL DESCRIPTION

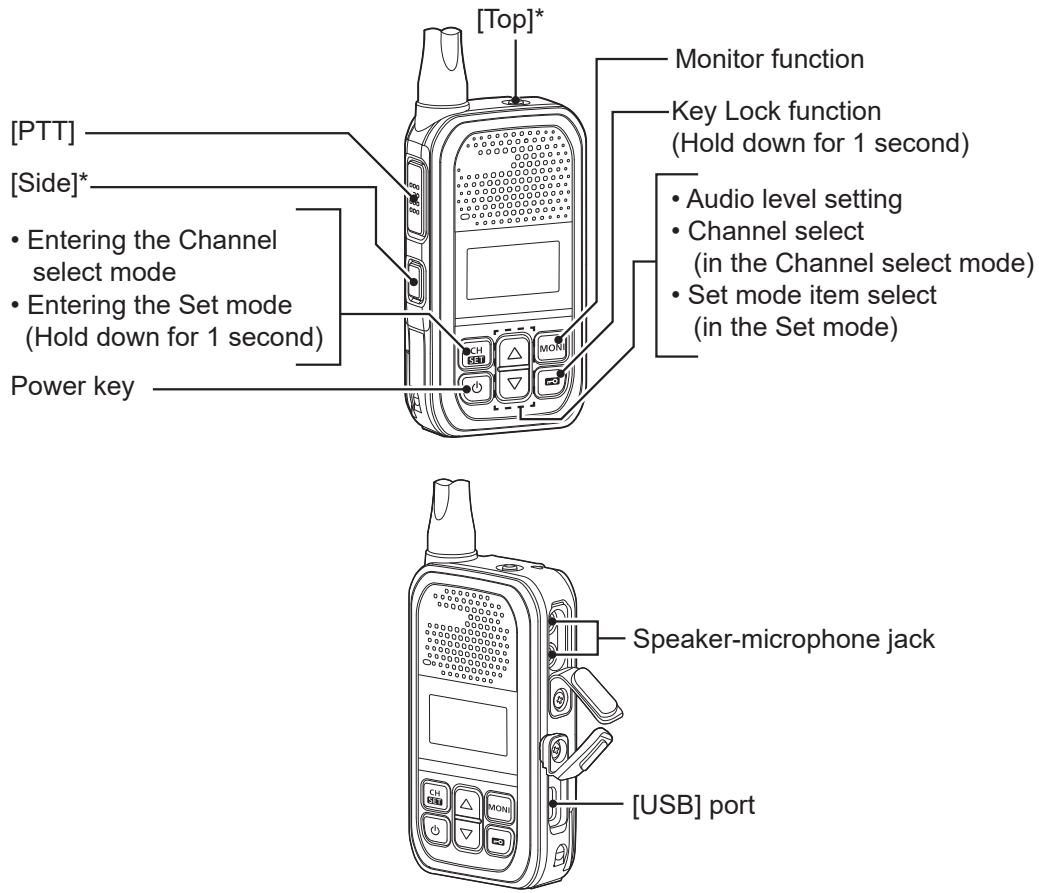

\*You can assign the desired functions to these keys using the optional CS-F200 programming software. (User Interface > Key Settings)

You can also assign another function to the [Side] and [Top] programmable function keys as the following operations.

1. Turn OFF the transceiver.
2. While holding down [MONI] and [Top], push [Power] to enter the Key Assignment mode.
  - “KYST” is displayed.



3. Push [Side] or [Top] to select the key that you want to reassign.
4. Push [▲] or [▼] to select a desired key function.
  - There are 5 options as follows.
  - 1: Null, 2: Emergency, 3: Scan Start/Stop, 4: Surveillance, 5: High/Low



When the surveillance function is assigned to [Side].

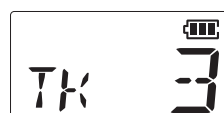

When the scan function is assigned to [Top].

5. Push [Power] to turn OFF the transceiver to exit the Key Assignment mode.

1-4 FUNCTION DISPLAY DESCRIPTION

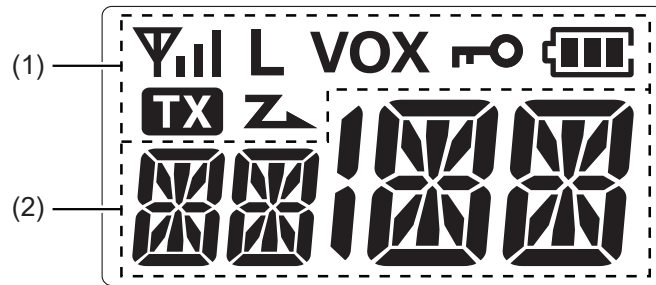

(1) Icon area

Displays the icons shown below.

Icon	Description
	<ul style="list-style-type: none"> <li>Displayed while the channel is busy (receiving a signal).</li> <li>Blinks while the monitor function is turned ON.</li> </ul>
	Displays the relative receive signal strength level.
<b>L</b>	Displayed when a low output power is selected.
<b>VOX</b>	Displayed when the VOX function is turned ON.

Icon	Description								
	Displayed when the Key Lock function is ON.								
	<ul style="list-style-type: none"> <li>Blinks while charging.</li> <li>Displayed the remaining battery charge.</li> </ul> <table border="1" style="width: 100%; text-align: center;"> <tr> <td></td> <td></td> <td></td> <td></td> </tr> <tr> <td>Full</td> <td>Mid</td> <td>Charging required</td> <td>Battery exhausted</td> </tr> </table>					Full	Mid	Charging required	Battery exhausted
Full	Mid	Charging required	Battery exhausted						
<b>TX</b>	Displayed while transmitting.								
	<ul style="list-style-type: none"> <li>Displayed when the channel is selected as a Scan Target channel.</li> <li>Blinks while scanning.</li> </ul>								

(2) Alphanumeric readout

Displays channel number, audio level, or Set mode item.

1-5 DIMENSIONS

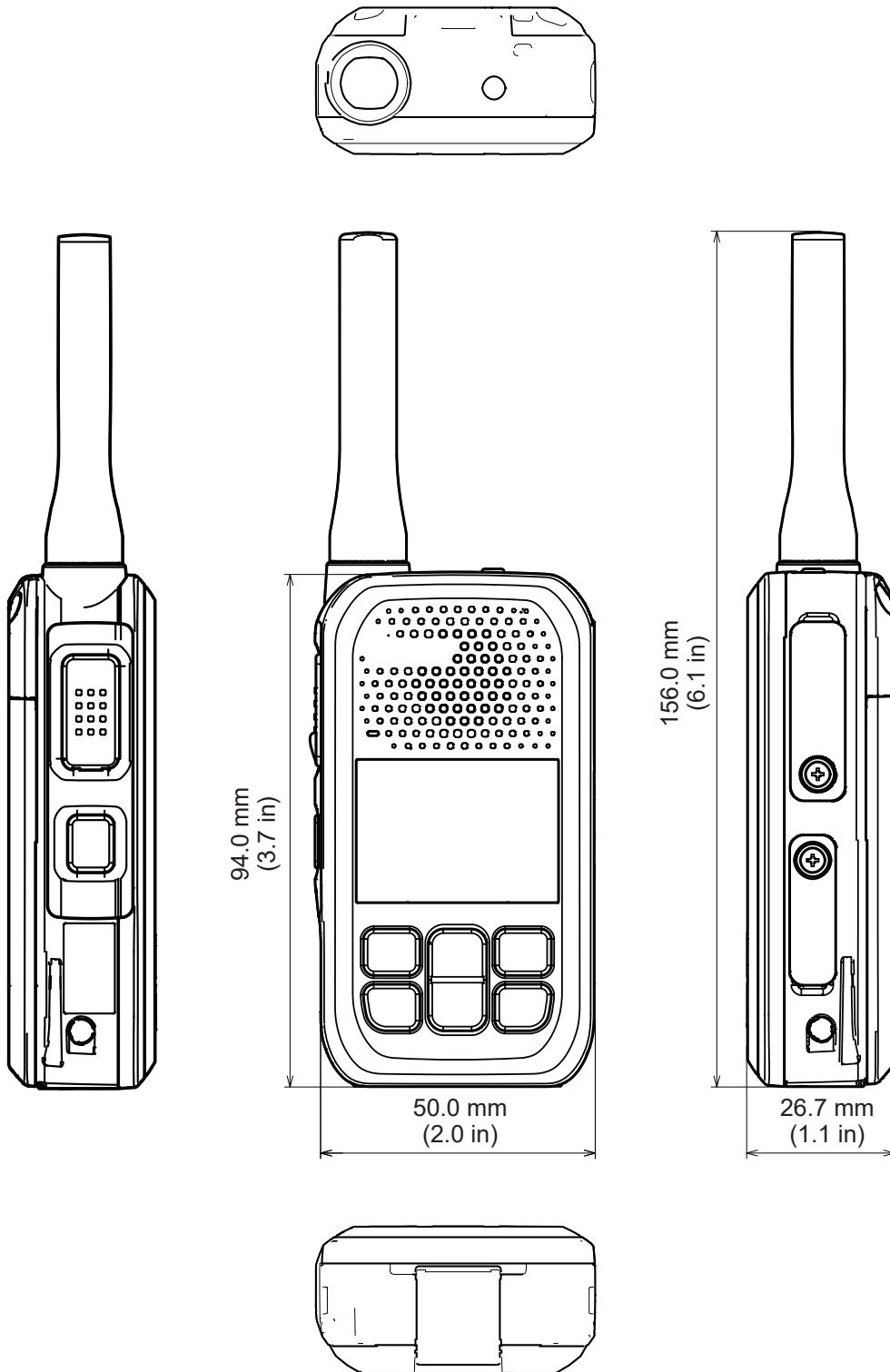

1-6 TARGET USERS



Supermarket



Restaurant



Hospital



Event



Academic

## SECTION 2 PRODUCT RANGE

The IC-F200 transceiver is positioned as the low-tier land mobile hand-held transceiver, as shown on the following analog transceiver's positioning map.

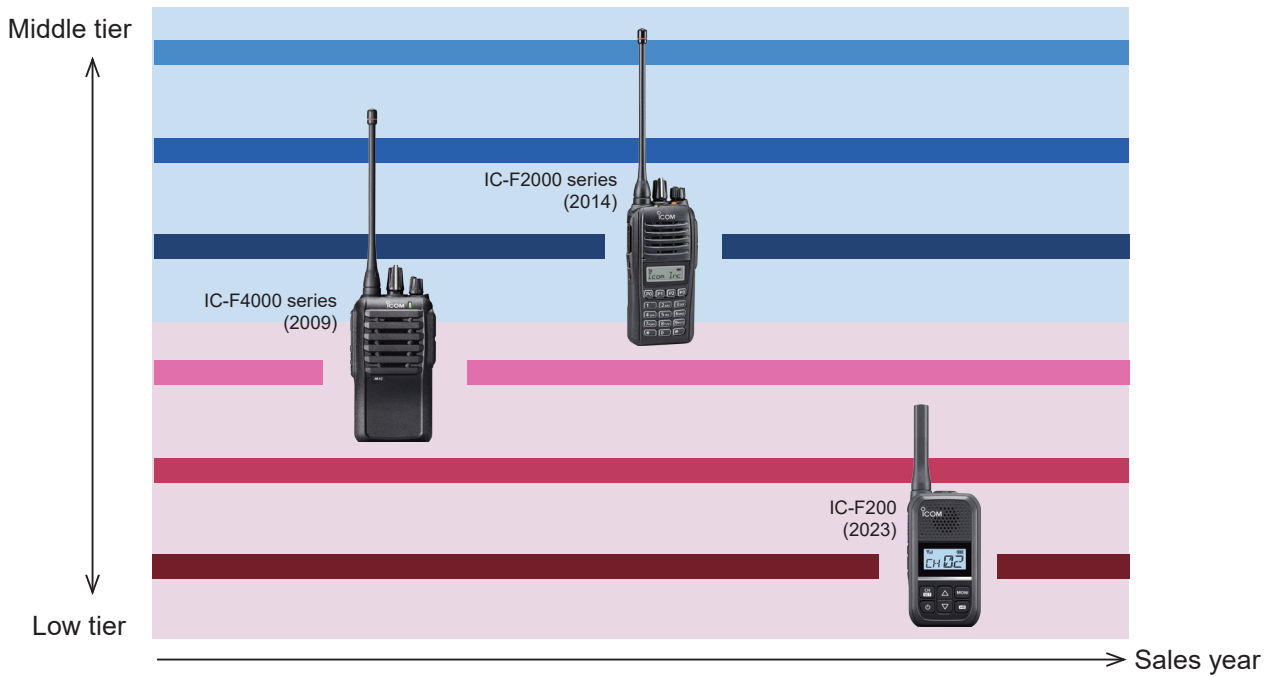



## SECTION 3 COMPARISON WITH OTHER ICOM MODELS

### 3-1 FUNCTION COMPARISON

MODEL	IC-F200	IC-F2000 SERIES	IC-F4000 SERIES
<b>ITEMS</b>			
<b>SIGNALLING</b>			
CTCSS	YES	YES	YES
DTCS	YES	YES	YES
2 TONE	NONE	YES	YES
5 TONE	NONE	YES	YES
MDC1200	NONE	YES	YES
BIIS	NONE	NONE	YES
<b>EMERGENCY AND SECURITY FUNCTIONS</b>			
Inversion voice scrambler	NONE	16-code	NONE
Emergency call	YES (TX only)*	YES	YES
Man Down function	NONE	YES	NONE
Lone Worker function	YES (TX only)*	YES	YES
Motion and Stationary Detection function	NONE	YES	NONE
Surveillance function	YES	YES	YES
Siren sound for security alarm	NONE	YES	YES
Power ON password	NONE	YES	NONE
<b>CHANNEL ANNOUNCEMENT AND VOX FUNCTIONS</b>			
Channel Announcement function	YES	YES	NONE
VOX function	YES	YES	YES
<b>AUDIO FUNCTIONS</b>			
Audio compander	NONE	YES	NONE
<b>HARDWARE</b>			
Programmable keys	YES (2 keys)	YES (7 keys) <sup>†</sup>	YES (3 keys)
Compatible IP level	IP54	IP67	IP54

\*The MDC 1200 compatible transceivers can decode a PTT ID signal from the IC-F200.

<sup>†</sup>For the IC-F2000S and IC-F2000T, no programmable key is available for the IC-F2000.

## 3-2 SPECIFICATION COMPARISON BETWEEN THE USA VERSION

MODEL		IC-F200	IC-F2000 series	IC-F4000 series
<b>GENERAL</b>				
<b>Frequency coverage (MHz)</b>		450~470	400~470*, 450~512*	400~470*, 450~512*
<b>Number of channels</b>		16	16 (Non-display model), 128 (display model)	16
<b>Power supply voltage (Negative ground)</b>		3.7 V DC nominal	7.5 V DC nominal	7.2 V DC nominal
<b>Current drain (Approximate)</b>	<b>RX</b>	0.8 A maximum	0.5 A (Internal speaker)	0.5 A (Internal speaker)
	<b>TX</b>	1.8 A maximum	1.3 A	1.6 A
<b>Dimensions (projections not included: H×W×D)</b>		94.0 × 50.0 × 26.7 mm: 3.7 × 2.0 × 1.1 in	111.8 × 52.2 × 29.5 mm: 4.4 × 2.1 × 1.2 in (with the BP-278)	111.0 × 58 × 38.2 mm: 4.4 × 2.3 × 1.5 in (with the BP-264)
<b>Weight</b>		157 g: 5.5 oz (with the BP-304A)	230 g: 8.1 oz (with the BP-278)	330 g: 11.6 oz (with the BP-264)
<b>TRANSMITTER</b>				
<b>Rated output power</b>		2.0 W or less	4 W	4 W
<b>Maximum permissible frequency deviation</b>		±2.5 kHz	±2.5 kHz	±2.5 kHz
<b>Frequency error</b>		±500 Hz	±2.5 ppm	±2.5 ppm
<b>Spurious emissions</b>		60 dB minimum, 80 dB typical	70 dB minimum	70 dB minimum
<b>Adjacent channel power</b>		60 dB minimum, 65 dB typical	60 dB minimum, 69 dB typical	60 dB minimum, 66 dB typical
<b>Audio harmonic distortion (at AF 1 kHz 40% Deviation)</b>		5.0% maximum	1.5% typical	1.5% typical
<b>FM Hum and Noise</b>		40 dB minimum, 56 dB typical (without a CCITT filter)	34 dB minimum, 40 dB typical (without a CCITT filter)	34 dB minimum, 40 dB typical (without a CCITT filter)
<b>Limiting characteristics of the modulator</b>		70%~100% of maximum deviation	60%~100% of maximum deviation	60%~100% of maximum deviation
<b>RECEIVER</b>				
<b>Sensitivity (12 dB SINAD)</b>		0.18 μV typical	0.25 μV typical	0.25 μV typical
<b>Audio power output</b>	<b>Internal SP</b>	0.6 W typical at 5 % distortion into the 4 Ω	1.5 W typical at 5 % distortion into the 8 Ω	1.5 W typical at 5 % distortion into the 8 Ω
	<b>External SP</b>	0.15 W typical at 5% distortion into an 8 Ω	0.4 W typical at 5 % distortion into an 8 Ω	0.4 W typical at 5 % distortion into an 8 Ω
<b>Adjacent channel selectivity</b>		45 dB minimum, 52 dB typical	60 dB minimum, 67 dB typical	60 dB minimum, 65 dB typical
<b>Intermodulation</b>		55 dB minimum, 64 dB typical	70 dB minimum, 73 dB typical	70 dB minimum, 74 dB typical
<b>Hum and Noise</b>		40 dB minimum, 47 dB typical (without a CCITT filter)	40 dB minimum, 47 dB typical (with a CCITT filter)	34 dB minimum, 47 dB typical (without a CCITT filter)
<b>Squelch sensitivity (Threshold)</b>		0.16 μV typical	0.25 μV typical	0.25 μV typical

Specifications: Measurements made in accordance with TIA-603 procedures

\*Depending on the version.

## 3-3 SPECIFICATION COMPARISON BETWEEN THE EXP VERSION

MODEL		IC-F200	IC-F2000 series	IC-F4000 series
<b>GENERAL</b>				
Frequency coverage (MHz)		450~470	400~470*, 450~520*	400~470*, 450~520*
Number of channels		16	16 (Non-display model), 128 (display model)	16
Type of emission	Narrow	11K0F3E	8K50F3E, 11K0F3E	11K0F3E
	Wide	16K0F3E	16K0F3E	16K0F3E
Power supply voltage (Negative ground)		3.7 V DC nominal	7.5 V DC nominal	7.2 V DC nominal
Current drain (Approximate)	RX	0.8 A maximum	0.5 A (Internal speaker)	0.5 A (Internal speaker)
	TX	1.8 A maximum	1.3 A	1.6 A
Dimensions (projections not included: H×W×D)		94.0 × 50.0 × 26.7 mm: 3.7 × 2.0 × 1.1 in	111.8 × 52.2 × 29.5 mm: 4.4 × 2.1 × 1.2 in (with the BP-278)	111.0 × 58 × 38.2 mm: 4.4 × 2.3 × 1.5 in (with the BP-264)
Weight		157 g: 5.5 oz (with the BP-304A)	230 g: 8.1 oz (with the BP-278)	330 g: 11.6 oz (with the BP-264)
<b>TRANSMITTER</b>				
Rated output power		2.0 W or less	4 W	5 W
Maximum permissible frequency deviation	Narrow	±2.5 kHz	±2.5 kHz	±2.5 kHz
	Wide	±5.0 kHz	±5.0 kHz	±5.0 kHz
Frequency error		±500 Hz	±2.5 ppm	±2.5 ppm
Spurious emissions		60 dB minimum, 80 dB typical	70 dB minimum	70 dB minimum
Adjacent channel power	Narrow	60 dB minimum, 65 dB typical	60 dB minimum, 69 dB typical	60 dB minimum, 66 dB typical
	Wide	65 dB minimum, 70 dB typical	70 dB minimum, 74 dB typical	70 dB minimum, 73 dB typical
Audio harmonic distortion (at AF 1 kHz 40% Deviation)	Narrow	5.0% maximum	1.5% typical	1.5% typical
	Wide		1.0% typical	1.0% typical
FM Hum and Noise (without a CCITT filter)	Narrow	40 dB minimum, 56 dB typical	34 dB minimum, 40 dB typical	34 dB minimum, 40 dB typical
	Wide	46 dB minimum, 56 dB typical	40 dB minimum, 46 dB typical	40 dB minimum, 46 dB typical
Limiting characteristics of the modulator		70%~100% of maximum deviation	60%~100% of maximum deviation	60%~100% of maximum deviation

Specifications: Measurements made in accordance with TIA-603 procedures

\*Depending on the version.

Continued on the next page...

MODEL		IC-F200	IC-F2000 series	IC-F4000 series
ITEMS				
<b>RECEIVER</b>				
<b>Sensitivity (12 dB SINAD)</b>		0.18 $\mu$ V typical	0.25 $\mu$ V typical	0.25 $\mu$ V typical
<b>Audio power output</b>	<b>Internal SP</b>	0.6 W typical at 5 % distortion into the 4 $\Omega$	1.5 W typical at 5 % distortion into the 8 $\Omega$	1.5 W typical at 5 % distortion into the 8 $\Omega$
	<b>External SP</b>	0.15 W typical at 5% distortion into an 8 $\Omega$	0.4 W typical at 5 % distortion into an 8 $\Omega$	0.4 W typical at 5 % distortion into an 8 $\Omega$
<b>Adjacent channel selectivity</b>	<b>Narrow</b>	45 dB minimum, 52 dB typical	60 dB minimum, 67 dB typical	60 dB minimum, 65 dB typical
	<b>Wide</b>	60 dB minimum, 68 dB typical	70 dB minimum, 75 dB typical	70 dB minimum, 73 dB typical
<b>Intermodulation</b>		55 dB minimum, 64 dB typical	70 dB minimum, 73 dB typical	70 dB minimum, 74 dB typical
<b>Hum and Noise</b>	<b>Narrow</b>	40 dB minimum, 47 dB typical (without a CCITT filter)	40 dB minimum, 47 dB typical (with a CCITT filter)	34 dB minimum, 47 dB typical (without a CCITT filter)
	<b>Wide</b>	40 dB minimum, 47 dB typical (without a CCITT filter)	45 dB minimum, 52 dB typical (with a CCITT filter)	40 dB minimum, 52 dB typical (without a CCITT filter)
<b>Squelch sensitivity (Threshold)</b>		0.16 $\mu$ V typical	0.25 $\mu$ V typical	0.25 $\mu$ V typical

Specifications: Measurements made in accordance with TIA-603 procedures.

## SECTION 4 COMPARISON TO COMPETITORS

### 4-1 FUNCTION COMPARISON

ITEMS	MODEL	IC-F200	PKT-23	CLS1410
<b>SIGNALLING</b>				
CTCSS		YES	YES	YES
DTCS		YES	YES	YES
<b>EMERGENCY AND SECURITY FUNCTIONS</b>				
Emergency call		YES (TX only)*	NONE	NONE
Lone Worker function		YES (TX only)*	NONE	NONE
Surveillance function		YES	NONE	NONE
<b>CHANNEL ANNOUNCEMENT AND VOX FUNCTIONS</b>				
Channel Announcement function		YES	YES	NONE
VOX function		YES	YES	YES
<b>SCAN FUNCTION</b>				
SCAN function		YES	YES	YES
<b>PROGRAMMING</b>				
Air Clone		YES (Only for EXP version)	YES	NONE
<b>HARDWARE</b>				
Channel number display		YES	NONE	YES
Programmable keys		YES (2 keys)	YES (2 keys)	NONE
Compatible IP level		IP54	IP54	IP52

\*The MDC 1200 compatible transceivers can decode a PTT ID signal from the IC-F200.

## 4-2 SPECIFICATION COMPARISON

MODEL		IC-F200	PKT-23	CLS1410
<b>GENERAL</b>				
<b>Frequency coverage (MHz)</b>		450~470	451~470	459.5~469.5
<b>Number of channels</b>		16	4	4
<b>Bandwidth (kHz)</b>		12.5/25.0* *Only for EXP version	12.5	12.5
<b>Antenna impedance</b>		50 Ω nominal	50 Ω nominal	50 Ω nominal
<b>Operating temperature range</b>		-30°C to +60°C -22°F to +140°C	-30°C to +60°C -22°F to +140°C	-30°C to +60°C -22°F to +140°C
<b>Dimensions (projections not included: H×W×D)</b>		94.0 × 50.0 × 26.7 mm: 3.7 × 2.0 × 1.1 in	85.0 × 46.0 × 21.0 mm: 3.3 × 1.8 × 0.8 in	147.3 × 50.8 × 27.9 mm: 5.8 × 2.0 × 1.1 in
<b>Weight</b>		157 g: 5.5 oz	230 g: 8.1 oz	130.4 g: 4.6 oz
<b>TRANSMITTER</b>				
<b>Rated output power</b>		2.0 W or less	1.5 W (ERP)	1 W
<b>Spurious emissions</b>		60 dB minimum, 80 dB typical	55 dB	-20 dBm
<b>Audio harmonic distortion (at AF 1 kHz 40% Deviation)</b>		5.0% maximum	5.0% or less	2.0%
<b>FM Hum and Noise (without a CCITT filter)</b>	<b>Narrow</b>	40 dB minimum, 56 dB typical	50 dB	-40 dB
	<b>Wide</b>	46 dB minimum, 56 dB typical (Only for EXP version)	-	-
<b>RECEIVER</b>				
<b>Sensitivity (12 dB SINAD)</b>		0.18 μV typical	0.22 μV	0.18 μV
<b>Audio power output</b>		0.6 W typical at 5 % distortion into the 4 Ω	0.3 W with 5% or less distortion	0.5 W with 5% distortion into the 8 Ω
<b>Adjacent channel selectivity</b>	<b>Narrow</b>	45 dB minimum, 52 dB typical	60 dB	65 dB
	<b>Wide</b>	60 dB minimum, 68 dB typical (Only for EXP version)	-	-
<b>Intermodulation</b>		55 dB minimum, 64 dB typical	50 dB	60 dB

Specifications: Measurements made in accordance with TIA-603 procedures.

## SECTION 5 MAJOR FUNCTION INTRODUCTION

The major functions of the IC-F200 transceiver based on the main firmware Rev. 1.0 are described as follows.

### 5-1 EMERGENCY CALL

The IC-F200 can make an Emergency call by the following two methods.

#### • Using [Emergency]

Hold down **[Emergency]** on the top panel for 2 seconds\* (default setting), and the IC-F200 enters the Emergency mode.

When the Reminder Timer\* (default setting is 0 seconds) time has passed, the IC-F200 makes an Emergency call.

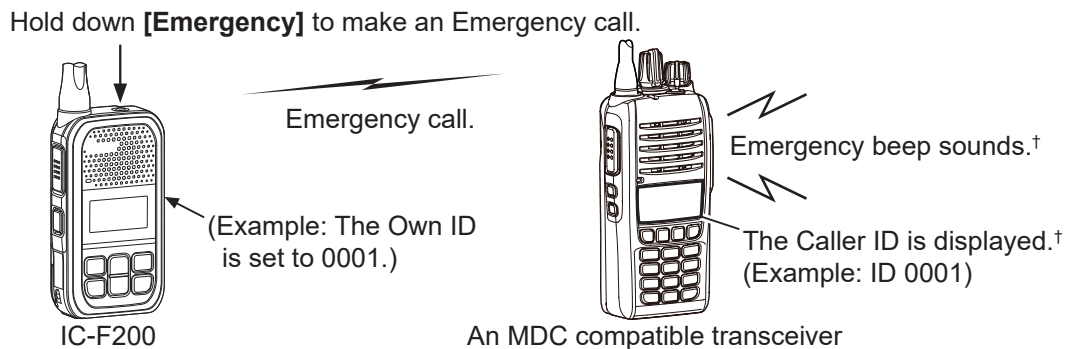

#### • Lone Worker

When no key operation is performed for the ON Timer preset time (default setting: 60 minutes\*), the IC-F200 enters Emergency mode, and the countdown starts. After the Reminder Timer (default setting: 60 seconds\*) time has passed, the IC-F200 makes an Emergency call.

\*The setting period can be changed using the CS-F200.

When no key operation is performed for the ON Timer preset time, the IC-F200 enters the Emergency mode. In addition, when the Reminder Timer has passed, the transceiver makes an Emergency call.

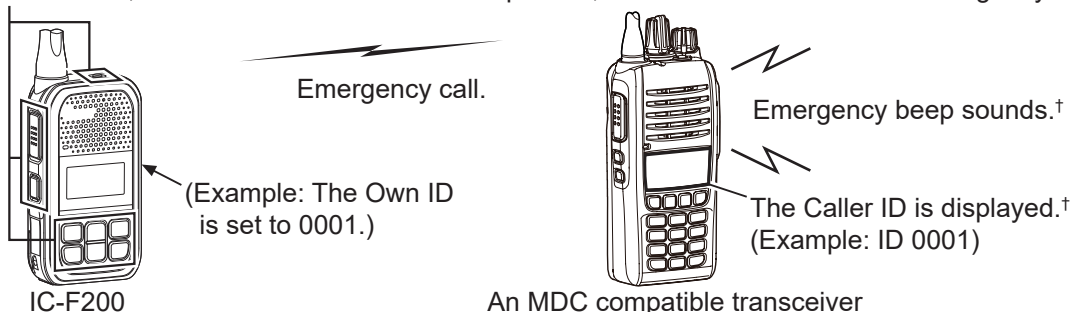

The MDC 1200 signal encoding is used for the IC-F200 Emergency call.

However, the IC-F200 does not have an MDC 1200 decoder, so another transceiver with an MDC 1200 decoder, such as the IC-F2000T, can receive an Emergency call and know who is in an emergency state.











†The Caller ID can only be displayed on an MDC 1200 compatible transceiver. However, the Emergency beeps sound on any transceiver, even transceivers incompatible with the MDC 1200.

## 5-2 AIR CLONE FUNCTION (FOR ONLY EXP VERSION)

The Air Clone function is helpful when simultaneously programming several IC-F200 transceivers with the same settings, even in the field.

- Setting period: Approximately 2 minutes.

To program the IC-F200 using the Air Clone function, operate the IC-F200 as follows.

Operation	Master transceiver 	Target transceivers 
<p><b>• STEP 1: PREPARATION</b> These operations are necessary for both the Master and Target transceivers. Turn OFF the transceivers. While holding down [SIDE] and [MONI], turn ON the transceiver to enter the Air Clone mode. Push [▲] or [▼] to select an Air Clone channel. The Master and Target transceivers must be set to the same channel.</p>		
<p><b>• STEP 2: START CLONING</b> On the Master transceiver, push [PTT] to start the Air Clone. - On the Target transceivers, no operation is necessary.</p>	 ▼ 	 ▼ 
<p><b>• CLONING IS FINISHED</b> When the Air Clone is finished.</p>	 ▼  Returns to the screen in STEP 1.	 ▼ Automatically turns OFF the transceiver. <b>NOTE:</b> When “PR NG” is displayed on the Target transceivers <ul style="list-style-type: none"> <li>• The Target transceivers may have missed the Air Clone signal or failed to decode the signal.</li> <li>• Try again or program the transceivers using the programming software in this case.</li> </ul>



## SECTION 6 OPTIONAL ACCESSORIES

Current (as of June 2023) optional accessories available for the IC-F200 transceiver are shown below.

### CHARGER

- **BC-262**



- **BC-263A**

(Cable length: Approximately 1900 mm/74.8 in,  
 Input voltage: 100~240 V AC 50/60 Hz,  
 Output voltage: 5.0 V,  
 Output current: Maximum 1.0 A,  
 USB connector type: USB Type-C™)

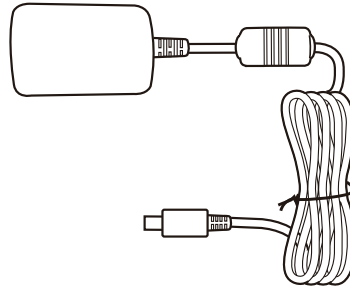

### BATTERY PACK

- **BP-304A** (DC 3.6 V, Minimum: 2270 mAh, Typical: 2350 mAh)



### BELT CLIP

- **MB-127**



**MICROPHONES**

- **HM-183LS**  
Speaker-microphone  
(Water and dust proof: IP67,  
Cable length: Approximately 0.52 m/20.5 in\*)



- **HM-186LS**  
Speaker-microphone  
(Water and dust proof: IP54,  
Cable length: Approximately 0.52 m/20.5 in\*)



- **HM-166LS**  
Tie-pin microphone with earphone  
(Cable length: Approximately 1.00 m/39.4 in,  
Ear phone cable length: Approximately 0.45 m/  
17.7 in)



- **HM-153LS**  
Tie-pin microphone with earphone  
(Cable length: Approximately 1.00 m/39.4 in)  
Ear phone cable length: Approximately 0.50 m/  
19.7 in)



\*When curled.

**HEADSETS AND ADAPTER CABLES**

- **HS-94**  
Earhook type with boom microphone  
(Cable length: Approximately 0.80 m/31.5 in  
Boom length: Approximately 0.09 m/3.5 in)



- **HS-95**  
Behind head type  
(Cable length: Approximately 1.00 m/39.4 in)  
Boom length: Approximately 0.12 m/4.7 in)



- **HS-97**  
Throat Microphone type  
(Cable length: Approximately 0.80 m/31.5 in  
Microphone cable length: Approximately 0.23 m/  
9.1 in)



- **OPC-2006LS**  
Adapter cable for HS-94, HS-95, and HS-97  
(Cable length: Approximately 0.13 m/5.1 in)



- **OPC-2328**  
Adapter cable with the PTT switch for HS-94,  
HS-95, and HS-97  
(Cable length for transceiver:  
Approximately 0.77 m/30.3 in,  
Cable length for headset:  
Approximately 0.14 m/5.5 in)



Revision record

Version	Month/Year	The revised contents
Version 1.0	June 2023	First issue.

How the World Communicates

**Icom Inc.**

1-1-32 Kamiminami, Hirano-ku, Osaka 547-0003, Japan <https://www.icomjapan.com/>