

# FLEX

PROFESSIONAL REPEATER

## USER GUIDE



*Genuine*  
blackbox

## [ Contents ]

<b>Packing list</b> .....	<b>3</b>
<b>Radio controls</b> .....	<b>4</b>
Parts description.....	4
TFT Statu Icons.....	7
LED indicator.....	9
<b>Preparation for operating the terminal</b> .....	<b>9</b>
Install the antenna.....	9
Power cord connection.....	9
Speaker Microphone installation .....	10
Programmable keys.....	10
Programmable functions.....	10
Buttons operation.....	11
Numeric keypad operation of Speaker microphone.....	11
Recognition of transmitting and receiving ICONS.....	12

## [ Contents ]

<b>PTT call</b> .....	<b>12</b>
Digital channel call.....	12
Analog mode initiating and receiving calls (no signaling)..	12
<b>Main menu contains item index .....</b>	<b>13</b>
<b>Menu accessing and operation .....</b>	<b>13</b>
<b>Main functions description .....</b>	<b>14</b>
<b>Scan and Roaming .....</b>	<b>16</b>
<b>Roaming Mode Selection .....</b>	<b>16</b>
<b>Precautions for Roaming.....</b>	<b>18</b>
<b>SFR repeater set.....</b>	<b>18</b>
<b>General guide for fault handling.....</b>	<b>19</b>
<b>Maintenance and clean.....</b>	<b>21</b>
<b>Accessories.....</b>	<b>22</b>

## Packing list

The following items are contained in the gift box. If any item is missing or damaged, please contact your dealer.

Item Name	Quantity (pc)	Item Name	Quantity (pc)
Radio unit	1	Speaker microphone	1
Power supply	1	User manual	1

 **Note:**

After purchase, please check the items and quantity in the box to ensure everything is correct.



# Radio Controls

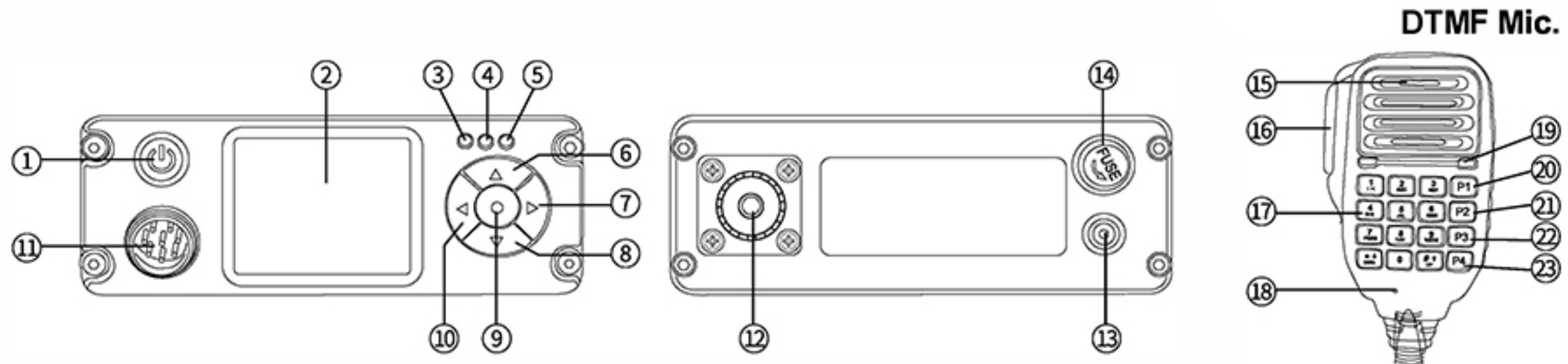

## Parts description & function applications

NO.	Part Name	Function description and applications
①	[⏻] Power Key	1) Press and hold for more than 3 seconds to power on or power off; 2) In Standby, short press it to switch A/B frequency band. The frequency band → with icon is the "main frequency band", can press PTT key to transmit or have menu set. 3) In menu mode, short press it to exit the current operation mode and return to standby interface;
②	TFT LCD Display	It is applied to display various working states and combined with visual icons, which is easy to use and operate;
③	Signal indicator	It is used for status indication in receiving (green light), transmitting (red light) and repeater (orange light);
④	Charging indicator	Used to indicate the charging status (lights red in charging, and lights green when fully charged); Note: If the built-in battery is not purchased, the LED does not light up when the power is on.
⑤	Repeater indicator	It lights blue when repeater is on, and lights green when repeater is off.
⑥	[▲] button	1) In Standby, short press it to increase the volume. Long press it to start the current band scanning, and scan the channel/frequency in the upward direction; 2) In menu mode, short press it to select menu and other parameters upward;

NO.	Part Name	Function description and applications
⑦	[ ▶ ] button	1) In Standby, works as a function key. Short press it to change the channel properties, or cooperate with the [▲/▼] key to select the frequency or channel. Long press it to open or close the repeater function; 2) In menu mode, works as BACK key.
⑧	[ ▼ ] button	1) In Standby, short press it to decrease the volume, long press it to start the current band scanning, and scan the channel/frequency in the downward direction; 2) In Menu mode, short press it to select menu down;
⑨	[ ● ] button	1) In Standby, short press it to access the menu of the "Main Band" with → icon; 2) Select the desired menu item; short press it to work as [Select] key or [Confirm] key for parameter settings.
⑩	[ ◀ ] button	User-defined button
⑪	Jack for Speaker microphone and PC connection set	1) Connect the equipped original speaker microphone to this jack; 2) Connect the PC data cable to this jack for PC programming;
⑫	Antenna Port	External antenna is connected to this port. Connect a dummy load in place of the antenna when testing transmitting. The antenna system or load should have an impedance of 50Ω.
⑬	Power Jack	Insert the DC power cord into this jack to power on (power supply voltage: DC12~48V);
⑭	Fuse Holder	For replacing or installing fuses;
⑮	Speaker microphone	Used to receive audio from others (Audio output options can be set from the menu option)
⑯	[PTT] key	Press and then speak in to the microphone to transmit; Release it to receive.
⑰	Numeric Keypad	Used to input frequency / channel number, alias, ID and SMS
⑱	MIC	Speak to the microphone when pressing the PTT key to transmit; (3-5CM from the mouth)



NO.	Part Name	Function description and applications
②⑤	LED indicator of the speaker microphone	In transmitting, LED lights red; if operating on speaker microphone keypad, LED light will be always on.
②⑥	MIC P1	Programmable function key 1 of speaker microphone
②⑦	MIC P2	Programmable function key 2 of speaker microphone
②⑧	MIC P3	Programmable function key 3 of speaker microphone
②⑨	MIC P4	Programmable function key 4 of speaker microphone

 **Note:**





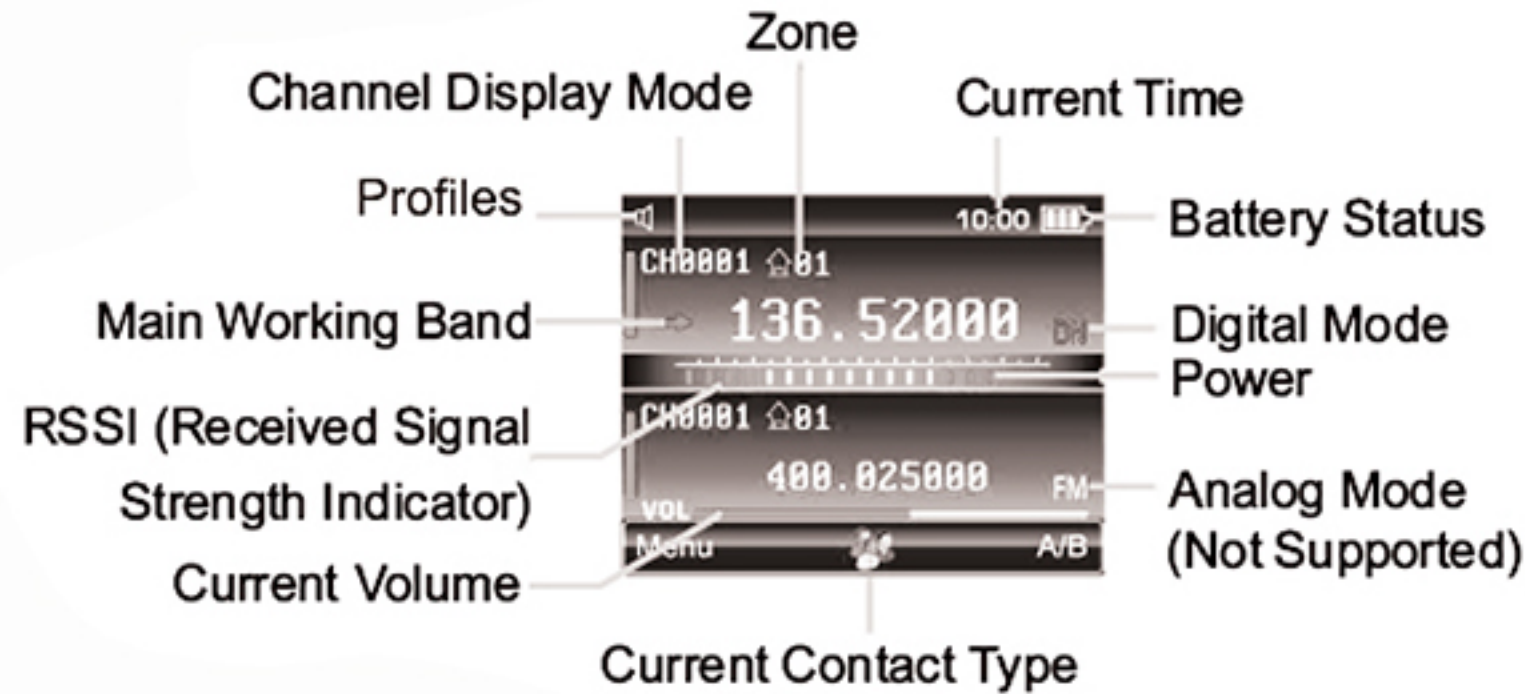







For convenient use, there are programmable keys for definition.

## TFT Statu Icons



Icon	Icon description	Applications and function description
	Main Working Band	1).Indicate to transmit on the current band when*PTT*key pressed; 2).Indicate the band that can be operated and set currently
	High Power	6 red bars indicate high power
	Low Power	3 red bars indicate low power
	Standby	White bars indicates the radio being in standby mode
	RSSI	In RX mode, the more green bars, the stronger signal
	Keylock	Appears when the keypad is locked.
	Battery Status	The more bars, the larger battery capacity; and vice versa
	Monitor	Appears when Monitor is ON.
	VOX	Appears when VOX is ON.
	GPS	Appears when GPS is ON.
	Scan	Appears when normal scan is ON.
	Emergency Mode	Appears when the radio is in emergency mode.
	Encryption	Appears when Encryption is ON.



Icon	Icon description	Applications and function description
QT	CTCSS	In analog mode, appears when CTCSS is ON. (Not Supported)
DQT	CDCSS	In analog mode, appears when CDCSS is ON. (Not Supported)
	Prompt Tone on	Appears when profile is in standard mode.
	Prompt Tone Off	Appears when profile is in silent mode.
	Talk Around	Appears when the radio is in talk around mode.
	Roaming	Appears when roam scan is activated. (White Icon)
	Roaming Lock	For locking current channel in Roaming
	Offset Frequency Negative direction	Appears when RX frequency is higher than TX frequency.
	Offset Frequency Positive direction	Appears when TX frequency is higher than RX frequency.
<b>DN</b>	Digital Mode	Indicates the current band working in digital mode
<b>FM</b>	Analog Mode	Indicates the current band working in analog mode (Not Supported)
<b>DN</b>	Digital/Analog Mode	The current band is in digital/analog auto RX mode. Digital Mode is for main TX
<b>DN</b>	Analog/Digital Mode	The current band is in analog/digital auto RX mode. Analog Mode is for main TX
	Time Slot 1	Indicates the working slot of current frequency or channel
	Time Slot 2	Indicates the working slot of current frequency or channel
	Zone	Indicates the working zone of current frequency or channel
<b>VFO</b>	Frequency Mode	Indicates working in frequency mode, can input frequency directly via numeric keypad
	SMS	Appears when received a new message.
	SFR repeater	Appears when SFR repeater is on.



## LED Indicators

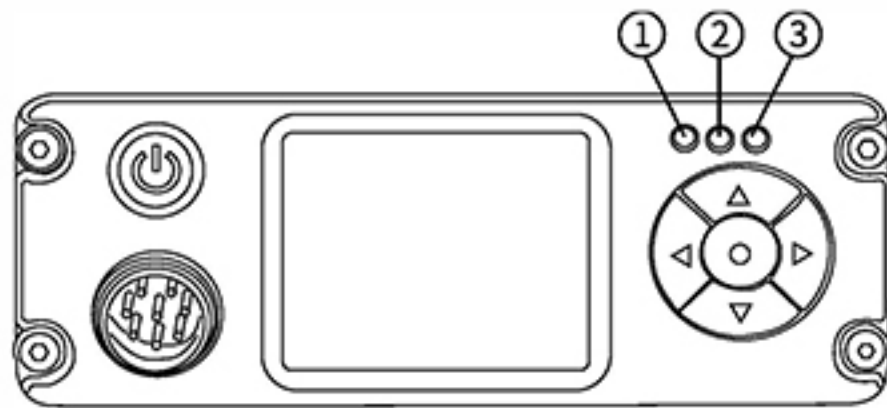

No.	LED indicator	Radio Status
1	● Green	Receiving
	● Red	Transmitting
	● Fast Flashing Green	Scanning
	● Slow Flashing Red	Low battery
	● Fast Flashing Orange	Repeater feature is in use.
2	● Green	Standby (No load) or Fully charged
	● Red	Charging
3	● Green	Repeater feature is off.
	● Blue	Repeater feature is on.

**Note:** if built-in battery is not optional, the charging indicator does not light up when the power supply is plugged in.

## Preparation for operating the terminal

### Install the antenna

1. Insert the threaded end of the antenna into the antenna port on the back of the radio.
2. Tighten the antenna clockwise.

**⚠** Do not hold the antenna with your hand, as this will reduce the radio performance.

### Power cord connection

When the radio is first start, a low-power alarm may appear. Please turn off and charge the radio before using it (the radio with built-in battery).

Please follow below steps to charge:

1. Plug the power supply into the jack on the back of the radio.
2. Insert the power supply into the power outlet.
3. Check the LED charging indicator to understand the current charging status.
4. For radios without built-in batteries, the charging indicator does not light up when the power supply is plugged in.

### **⚠ Note:**

- The input voltage range is: DC 12~48V.
- Please use the charging equipment designated by us for charging.
- Please refer to the charging safety information before charging to obtain the necessary battery safety information.

## Speaker Microphone Installation

To communicate by voice, connect the supplied speaker microphone to the jack on the front-left side of the radio. Insert the microphone plug to the jack hole and press firmly until it reaches the bottom, and then tighten the nut of the microphone plug.

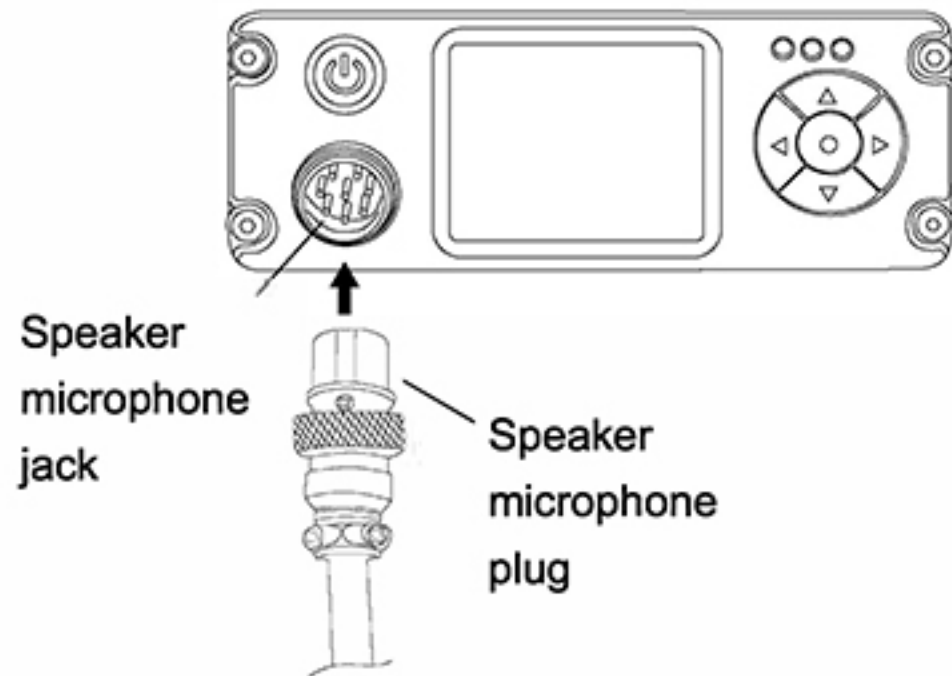

## Programmable Keys

- Short Press: press and release quickly (programmable range is from 50ms-750ms).
- Long Press: press and hold for programmed time length (programmable range is from 500ms-5000ms).

## Programmable Functions

If desired, the following terminal features can be preset for programmable keys:

Type	Features	Description
	Radio Revive	Revive a target radio that has been remotely disabled
	Radio Detection	Determine if targeted radio is active
	Radio Kill	Disable targeted radio remotely
	Remote Monitor	Covert activation of targeted radios transmitter without local indicators.
	Encryption On/Off	Turn on/off encryption
	Emergency On/Off	Initiate an emergency alarm mode or call based on programmed preset.
	Contacts	Direct access to the programmed contact list
	Permanent Monitor	Always monitor the selected channel until disabled.
	Zone Switch	Changes from selected Zone to new Zone
	Scan On/Off	Turn scanning on/off
	VOX On/Off	Switch between VOX On and Off.
	Backlight On/Off	Turn backlight On/Off
	Keypad Lock	Switch between keypad lock and unlock.
	SMS	Direct access to SMS list
	High /Low Power	Switch transmit power between high and low power
	Roaming On/Off	Turn on/Off Roaming
	Repeat / Talk Around Selection	Switch between the Repeat and Talk Around Mode
	Monitor	Press this key to turn on / off the radio receiving squelch circuit.Receive weak analog signals in the air.
	DTMF On/Off	Turn On/Off DTMF

## Buttons Operation

The following keys can be used to quickly achieve the desired functions

Keys	Status	Operation	Description
[⏻] Power button	Standby	Short Press	Select [A/B] Main / Additional frequency band
		Long Press	Power On / Off the radio
	Access to the Menu Mode	Short Press	Exit the current operation mode, and return to the Standby mode.
[▲] button	Standby	Short Press	Increase the volume
	Access to the Menu Mode	Short Press	Select menu and other set parameters;
	Standby	Long Press	Turn on the current main band scanning, and scan the channel / frequency in the upward direction.
[▼] button	Standby	Short Press	Decrease the volume.
	Access to the Menu Mode	Short Press	Select menu and other set parameters;
	Standby	Long Press	Turn on the current band scanning, and scan the channel/frequency in the downward direction;
[▶] button	Standby	Short Press	Operation and setting of channel/VFO programming and parameters; Enter the channel setting and work with the [▲/▼] key to change the channel;
		Access to the Menu Mode	Short Press
	Standby	Long Press	Turn on or off the repeater feature

Keys	Status	Operation	Description
[◀] button	Standby	Short Press	Preset function based on user-defined
		Long Press	Preset function based on user-defined
[●] button	Standby	Short Press	Access the main menu
		Long Press	[Lock Key] or [Unlock Key]
	Access to the Menu Mode	Short Press	[Confirm] or [Select]



## Operations for Speaker microphone keypad

The numeric keypad of the speaker microphone can be used to access the radio functions. It can be used to input frequency/channel number, user alias or ID or SMS. Many characters require pressing a key for several times

### Keystrokes













Keypad	1	2	3	4	5	6	7	8	9	10	11	12	13	14	15	16	17	18	19	20	21	22	23	24	25	26	27	28	29	30	Note
[1]	,	o	?	!	:	;	,	"	"	'	'	(	)	«	»																"PY" input mode
[2]	.	,	'	?	!	-	(	)	@	/	:	_	;	+	&	%	*	=	<	>	\$	[	]	{	}	~	^	'	#	!	"AB" / "ab" input mode
[3]	A B C																														
[4]	D E F																														
[5]	G H I																														
[6]	J K L																														
[7]	M N O																														
[8]	P Q R S																														
[9]	T U V																														
[0]	W X Y Z																														



	Note: in the digital editing mode, a short press of this key enters the value of "0", while long press enters the symbol "+" in the digital, English and Chinese editing mode.
	Note: in the digital, English and Chinese editing mode, a short press of this key enters the "" symbol, and a long press enters a "space".
	Note: in the editing mode of Numbers, English and Chinese, a short press of this key inputs the symbol "#", while a long press switches between the editing input mode of English, Numbers, Chinese (pinyin) (" AB "in upper case," ab" in lower case," 12 "in figure," PY "in Chinese pinyin)

## Transmit / Receiving ICONS





The following icon appears on the radio screen to indicate the radio status.

Mode	Type	ICON	Terminal product status
	Private call		Sending a private call
			Receiving a private call
	Group Call		Sending a group call
			Receiving an group call
	All Call		Sending an All Call
			Receiving an All Call
	—		Sending an analog transmission
			Receiving an analog transmission

To ensure an optimal transmission, hold the radio in a vertical position at one to two inches (2.5 to 5.0 centimeters) away from the mouth.

## Digital channel call

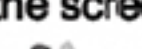
Digital calls are made as a group call, private call or All Call based on the programming of the radio. An individual channel may be preset to one of these calling functions.

Call type	Operation method	
	Making call	Receiving call
Private call	In standby mode, press [PTT] key to initiate the call. When a call is initiated, the screen displays:  ;	When a private call received, the screen displays:  ;
Group call	When initiated a group call, the screen displays:  ;	When a group call received, the screen displays:  ;
All call	When Initiated an all call, the screen displays:  ;	When an all call received, the screen displays:  ;









**This repeater does NOT support Analog transmission.**





**PTT call**



## Main menu contains item index

The menu options supported by the radio are shown in the following table. Please refer to the instruction for the "call" operation of individual call, group call and analog channel call. Other functions require access to the menu for configuration or implementation. [PF] definable key is the function shortcut key, and the specific function is preset by the programming software.

No.	Icon	Main Menu Item	Available setting items
1		Contacts	Contact List, New contact, Manual Dial
2		Message	Create Msg, Comm Msg, Inbox, Outbox, Draft box.
3		Call log	Dialed Numbs, Received Calls, Missed Calls.
4		Scan	Scan (On/Off), Scan List, Scan Mode, Roam Scan
5		Zone&Channel	Zone List
6		Local Set	Language, Keypad lock, Back Light, LEDs, Display Mode, VOX, Factory Reset, Single Frequency Repeater Setting
7		Parameters	TOT, Power, Repeat, Sleep Mode, SQ Level, Band, BCLO, Signaling, Enc Level
8		Tone Set	Profiles, Key Tone, Power Tone, Msg Tone, P Call Tone, G Call Tone, Alert Tone, Power On Tone.





No.	Icon	Main Menu Item	Available setting items
9		Appendix	GPS(Optional), FM Radio, Time, DTMF (Optional)
10		Record	Record Set, Record List, Clear Record, Space Info.
11		Device Info	Radio ID, RX Group List, CH contact, Version.
12		Self-programming Mode	Self-program the channel of current band(CTRL stays) or various parameters of VFO mode. Including: Mode selection, frequency, power, etc

## Menus accessing and operation

You can access the main menu and sub-menu options of the radio through the following steps, as well as functions such as setting or browsing the parameters and configuration, and viewing and sending short messages.

### Note:

Access to sub-menu:

- ◎ Icon "  " or "  " refers to ON/OFF.
- ◎ Icon "  " or "  " refers to " Selected " and " Set " .
- ◎ Icon "  " refers to access of the next sub-menu.

### Procedures:

When the radio is in standby:

1. Press [ ● ](Menu) key to access to menu.
  2. Press [ ▲ ] or [ ▼ ] key to select a desired setting "main menu", then press [ ● ](Menu) key to select.
  3. Press [ ▲ ] or [ ▼ ] key to a desired "Sub-menu" setting, then press [ ● ](Menu) key to select.
- ◆ If necessary, you can set each parameter or turn on/off by pressing the [ ▲ ] or [ ▼ ] keys, and then press the [ ● ](Menu) key to confirm.

**OR**

- Press [Back] key to back to previous menu.
4. Press [ ⏻ ] key to exit the current menu operation mode, and the terminal will revert to the standby state.
- If necessary, you can continue browsing, viewing, and setting other functions or parameters by performing steps #2 and #3.

## Main functions description

Classification	Function	Description
<b>Public Functions</b>	VFO Mode	In VFO mode, the user can directly input the required frequency through the numeric keyboard
	Zone	A zone is a group of channels. The radio supports 16 zones and contains up to 4000 channels.
	Power	The power level is for the transmission power level of the current channel, which can be set to high or low power.
	Scan	When the terminal scans a signal on a channel, it will stay on the channel to listen, so as to understand the current activity status of the relevant team members.
	Emergent alarm	Emergency alarm has the highest priority.
	Vox	The radio transmits when voice is detected by the microphone
	Busy channel lockout	Busy channel lockout prohibits transmission and prevents interference to other users when the radio is receiving traffic.



Classification	Function	Description
<b>Public Functions</b>	TOT	When a transmission times out, the terminal will automatically terminate the transmission and issue a warning sound.
	Keyboard lock	Keyboard lock is used to lock keys to prevent inadvertent key operation. The radio may be set to automatic or manual lock mode.
	Power saving	Power saving is a preprogrammed function based on time that places radio into a sleep-wake mode to conserve the battery.
<b>Digital functions</b>	Private call	Private call is a one-to-one call.
	Group call	Group call is a one-to-many call.
	All call	All call is a call to all contacts on the current digital channel.
	Talk around	Talk around allows communications on the repeaters output frequency.
	Roaming Setting	Roam Mode, RSSI Set, Connect Check Timer, Connect Re Check Timer, Connect Timer
	Roaming	When the radio moves from one site to another, it will automatically find the next available site through roaming.
	TDMA direct mode	TDMA direct mode is used to divide a direct channel (simplex) into two time slots to allow efficient channel usage. Multiple parties may share the channel without interference depending on slot setting.

Classification	Function	Description
<b>Analog functions (Not Supported)</b>	DTMF RX / TX reminder	Used as the TX PTT prompt tone and RX prompt tone before receiving the voice.
	Analog channel call	An analog call is a call on an analog channel. (Not Supported)
	Squelch ON	This setting exhibits an open squelch condition where both traffic and noise can pass to the speaker.
	Squelch level	Squelch level allows the manual setting of the squelch from 1 to 9. This controls at what point that audio can be sent to the speaker. The default value is 4. The lower the set value, the more chance of noise and weak signals being heard.
	Monitor	Monitor allows the user to open the receiver squelch manually to listen to on-channel signals.
	CTCSS	CTCSS code for RX radio must be same as TX radio, so that the audio can be received successfully
	DCS	DCS code for RX radio must be same as TX radio, so that the audio can be received successfully

## Scan & Roaming

The scanning type (**Scan ON / OFF, Roam Scan ON / OFF**) of the radio can be enabled or disabled by following ways.

### 1. Scanning

(1). Select the "**Scan**" item by accessing the main menu, and access the submenu to select the "**Scan ON / OFF**", then press the [▲] or [▼] key to turn on or off the scanning.

(2). Long press [▲] or [▼] key to turn on the scanning, and press any key to turn off the scanning.

(3). Short or long press the preset [**Scan ON/OFF**] key to enable or disable the scanning.

### 2. Roaming

(1). Select the "**Scan**" item by accessing the main menu, and access the submenu to select the "**Scan ON/OFF**", then press the [▲] or [▼] key to turn on or off roaming.

(2). Short or long press the preset [**Roam Scan ON / OFF**] key to enable or disable the roaming.

#### Notes:

1. Before turning on any scan mode, be sure to select "**Scan List**" in advance, otherwise, the scan function can't be activated.
2. When the scanning is on, all receivable channels in the scan list will be started scanning by the radio.
3. When the Roaming is on, all the repeater channels with RX/TX inter-frequencies in scan list will be started to scanning, but the channels with same RX/TX frequencies in scan list will not be scanned.

## Roaming Mode Selection

The roaming mode selection and roaming parameters set can be done by accessing the **Scan** item of main menu and then entering the submenu to select "**Roam Scan**" item icon.

### 1. Roam Mode

Roam Mode	Description
Auto	Once an available site from members of the scan list is searched, the radio will lock to the current available site and pause auto roaming. Then, it will shake hands with the current site according to the preset Connect Check Timer. If the radio fails to handshake in the preset connection times, it will restart strong signal automatic roaming search.
Manual	Users can manually roam to the next available site. Once it is on, all repeater channels in the scan list will be waken up to search the nearest available sites until an available site is found. Every time the nearest available site is found, a site search timer is started. Users can also lock the site by short pressing the [OK] key. The next available site is not necessarily the one with the largest RSSI value among the members of the scan list.



Roaming Mode	Description
RSSI	Once a site in the members of the scan list that exceeds the preset RSSI value is searched by strong signal automatic roaming, the radio will lock to the current member channel and pause the strong signal automatic roaming. Then it will shake hands with the current site according to the preset Connect Check Timer. If the radio fails to handshake in the preset connection times, it will restart strong signal automatic roaming search.

## 2. RSSI Set

The received signal strength (RSSI value) is settable. If the strong signal roaming mode is enabled and the RSSI value of the current site is found to exceed the preset one, the site's transmitting signal coverage will be automatically recognized as good, then the radio will suspend strong signal roaming.

Range (Unit: dBm)	
Maximum	-90dBm
Minimum	-125dBm
Increment	-1dBm

## 3. Connect Check Timer

The nearest available site is searched by manual roaming, the radio will immediately start timing according to the preset dwell time value. If the [OK] key is not pressed to confirm the use of the current site within the preset time, once the timer reaches the preset time, the radio will stop roaming; or restart the roaming to find the next available site.

### Site Searching Timer Setting

Range (Unit: second)	
Maximum	255
Minimum	0
Increment	1

### Note:

The stayed site is not necessarily the one with the largest RSSI value among the members of the roaming (scan) list.

## 4. Connect Re Check Timer

When the available sites are searched by automatic roaming or strong signal roaming, the radio is confirmed to be locked to the currently available site and the roaming is paused. Then, the radio will transmit signals at regular intervals according to the preset site confirmation time to perform handshake confirmation with the current site. If the preset connection times of transmission (set on the connection times table) fails to shake hands with the currently available site, the radio will restart automatic roaming or strong signal roaming to search any nearest available repeater station.



### Connect Re Check Timer setting:

Range (Unit: second)	
Maximum	255
Minimum	0
Increment	1

### 5.Connect Timer setting:

Range (Unit: time)	
Maximum	10
Minimum	1
Increment	1

## Precautions for Roaming

### Precautions for Roaming

1. When the roaming is activated, if there is no TX/RX inter-frequency channels (repeater channels) in the scan list, after the radio scans the current selected scan list, it will exit the roaming function.
2. When the roaming is activated, the roaming will be available in the main band as default.
3. In the roaming, if the PTT icon stays in the A band and is pressed to transmit, the radio will temporarily stop the roaming and switch back to the channel where the roaming started before for transmission. The radio will continue to the roaming after releasing the [PTT] key.
4. In the roaming, the main band is not allowed to change by Up and Down key.

## Single Frequency Repeater (SFR) Setting

### Processes:

1. Access the menu and press the [▲/▼] key to select Radio setting, and press [MENU] key to enter.
2. Press the [▲/▼] key to select the Single Frequency Repeater (SFR) setting, and press [MENU] key to enter.
3. Press the [▲/▼] key to select the desired item, and press [MENU] key to enter the following options and procedures:
  - ①. **Receive RSSI Threshold** → press [MENU] key → press [▲/▼] key to set the required Receive RSSI Threshold: -125dBm, -123dBm, -121 dBm, -119dBm .....-90dBm. → Press [MENU] key → The screen prompts that the setting is completed → return to the previous menu;
  - ②. **Transfer Power** → press [MENU] key → press [▲/▼] key to set the required transfer power: 1.0W, 1.5W, 2.0W, 2.5W .....10.0W → Press [MENU] key → the screen prompts that the setting is complete → return to the previous menu;

**Note:** The larger the repeater power setting is, the farther the repeater communication coverage will be.

- ③. **Voice Landing Switch** → Press the [MENU] key to turn on or off the Voice Landing Switch;
  - ◇ **On:** With Voice Landing Switch on, when the repeater function is on, the local speaker microphone will hear the voice from the two radios that needs to be relayed.
  - ◇ **Off:** With Voice Landing Switch off, when the repeater function is on, the radio only transfers the signal, but the local speaker microphone will not hear the voice from the two radios that needs to be relayed.

## General guide for fault handling

Malfunction	Analysis of causes	Handling method
Radio fails to power on	The radio without built-in battery	Need to plug in the power cord to power on.
	The power cord is not plugged in properly	Re-plug the power cord and check if the power plug is firmly inserted
Receive signal decreases, is unclear or is interrupted.	Low battery voltage	Plug in the power cord to charge.
	Volume control at low value.	Adjust the volume to be higher.
	Antenna gets loose or antenna frequency is incorrect.	Power off radio, and re-install antenna, or change antenna with right frequency.
	Speaker is blocked or damaged.	Try to clear the outer speaker or contact your dealer.
	Using the radio under poor working environment or electromagnetic interference	Change working environment or shift antenna direction.
Unable to communicate with group members	The current working channel frequency or signaling value is different.	Change channel or reset signaling and frequency to be same as the group members
	The setting of Digital or Analog channel is incorrect.	Reprogram the current digital or analog channel.
	Out of range of group members	Move back within range
Noise or unrelated communications on current channel	Co-channel user interference	Change frequency or channel.
	Channel not programmed with correct signaling	Reprogram radio to correct signaling or change signaling to prevent interference.
Weak voice traffic with noise during communications	The communication distance is too great	Reduce range between users.
	Signals are blocked during to environment such as buildings and terrain.	Reduce range between users or move to unimpeded line of sight.

Malfunction	Analysis of causes	Handling method
Weak voice traffic with noise during communications	Strong local environmental interference.	Move away from interference source.
Failure to obtain GPS position (Optional)	Radio lacks optional GPS feature or satellite view blocked by environment.	Add GPS feature; move to open site with clear view of sky.

Antenna Sold Separately

