

# ICOM INSTRUCTIONS

## VHF TRANSCEIVERS

### IC-F3260 series

## UHF TRANSCEIVERS

### IC-F4260 series

Thank you for choosing this Icom product.  
**READ ALL INSTRUCTIONS** carefully and completely before using this product.  
**SAVE THIS INSTRUCTIONS** — This instruction sheet contains important operating instructions for the IC-F3261DT/DS, IC-F3262DT/DS, IC-F3263DT/DS VHF TRANSCEIVERS, and the IC-F4261DT/DS, IC-F4262DT/DS, IC-F4263DT/DS UHF TRANSCEIVERS.

## IMPORTANT

This instruction sheet includes some functions that are usable only when they are preset by your dealer. The transceiver may have other functions and operations that are not described in this instruction sheet. Ask your dealer for preset function details.

The GPS receiver may not work if the transceiver transmits near 510 MHz. This is due to the internal circuitry and does not indicate a transceiver malfunction.

## EXPLICIT DEFINITIONS

WORD	DEFINITION
<b>⚠ DANGER!</b>	Personal death, serious injury or an explosion may occur.
<b>⚠ WARNING!</b>	Personal injury, fire hazard or electric shock may occur.
<b>CAUTION</b>	Equipment damage may occur.
<b>NOTE</b>	If disregarded, inconvenience only. No risk of personal injury, fire or electric shock.

Icom is not responsible for the destruction, damage to, or performance of any Icom or non-Icom equipment, if the malfunction is because of:

- Force majeure, including, but not limited to, fires, earthquakes, storms, floods, lightning, other natural disasters, disturbances, riots, war, or radioactive contamination.
- The use of Icom transceivers with any equipment that is not manufactured or approved by Icom.

Icom, Icom Inc. and Icom logo are registered trademarks of Icom Incorporated (Japan) in Japan, the United States, the United Kingdom, Germany, France, Spain, Russia, Australia, New Zealand, and/or other countries.

AMBE+2 is a trademark and property of Digital Voice Systems Inc.

All other products or brands are registered trademarks or trademarks of their respective holders.

## Icom Inc. Count on us!

1-1-32 Kamiminami, Hirano-ku, A7016D-1EX-9  
Osaka 547-0003, Japan Printed in Japan  
Apr. 2020 © 2012–2020 Icom Inc.

## FCC INFORMATION

This equipment has been tested and found to comply with the limits for a Class A digital device, pursuant to part 15 of the FCC Rules. These limits are designed to provide reasonable protection against harmful interference when the equipment is operated in a commercial environment. This equipment generates, uses, and can radiate radio frequency energy and, if not installed and used in accordance with the instruction manual, may cause harmful interference to radio communications. Operation of this equipment in a residential area is likely to cause harmful interference in which case the user will be required to correct the interference at his own expense.

**CAUTION:** Changes or modifications to this transceiver, not expressly approved by Icom Inc., could void your authority to operate this transceiver under FCC regulations.

This device complies with Part 15 of the FCC Rules. Operation is subject to the condition that this device does not cause harmful interference.

## PRECAUTIONS

**⚠ DANGER! NEVER** short the terminals of the battery pack. Shorting may occur if the terminals touch metal objects such as a key, so be careful when placing the battery packs (or the transceiver) in bags, and so on. Carry them so that shorting cannot occur with metal objects. Shorting may damage not only the battery pack, but also the transceiver.

**⚠ DANGER! NEVER** operate the transceiver near unshielded electrical blasting caps. This could cause an explosion and death.

**⚠ DANGER! NEVER** use and charge Icom battery packs with non-Icom transceivers or non-Icom chargers. Only Icom battery packs are tested and approved for use with Icom transceivers or charged with Icom chargers. Using third-party or counterfeit battery packs or chargers may cause smoke, fire, or cause the battery to burst.

**⚠ WARNING! NEVER** operate with earphone, headphones or other audio accessories at high volume levels. If you experience a ringing in your ears, reduce the volume level or discontinue use.

**⚠ WARNING! NEVER** operate the transceiver while driving a vehicle. Safe driving requires your full attention—anything less could result in an accident.

**CAUTION: DO NOT** use harsh solvents such as Benzene or alcohol when cleaning. This could damage the equipment surfaces. If the surface becomes dusty or dirty, wipe it clean with a soft, dry cloth.

**CAUTION: DO NOT** carry the transceiver by holding the antenna.

**CAUTION: DO NOT** operate the transceiver unless the flexible antenna, battery pack, and jack cover are securely attached to the transceiver, and that the antenna and battery pack are dry before attachment. Exposing the inside of the transceiver to dust or water will result in serious damage to the transceiver.

**CAUTION: DO NOT** place or leave the transceiver in areas with temperatures below  $-25^{\circ}\text{C}$  ( $-13^{\circ}\text{F}$ ) or above  $+55^{\circ}\text{C}$  ( $+131^{\circ}\text{F}$ ); European version, below  $-30^{\circ}\text{C}$  ( $-22^{\circ}\text{F}$ ) or above  $+60^{\circ}\text{C}$  ( $+140^{\circ}\text{F}$ ); other versions. The basic operations of the transceiver are guaranteed within the specified operating temperature range. However, the Liquid Crystal Display may not operate correctly, or show an indication in the case of long hours of operation, or after being placed in extremely cold areas.

**CAUTION: DO NOT** modify the transceiver. The specifications may change and then the transceiver may not comply with the requirements of required regulations. The transceiver warranty does not cover any problems caused by unauthorized modification.

**BE CAREFUL!** The transceiver will become hot when operating it continuously for long periods of time.

**BE CAREFUL!** The transceiver meets IP67\* requirements for dust-tight and waterproof protection. However, once the transceiver has been dropped, dust tight and waterproof protection cannot be guaranteed because of possible damage to the transceiver's case or the waterproof seal. \* Only when the supplied battery pack, flexible antenna and connector cover are attached.

Even when the transceiver power is OFF, a slight current still flows in the circuits. Remove the battery pack from the transceiver when not using it for a long time. Otherwise, the installed battery pack will become exhausted, and will need to be recharged or replaced.

**ALWAYS** turn OFF the transceiver before connecting any external devices.

## ⚡ Battery caution

Misuse of Li-ion batteries may result in the following hazards: smoke, fire, or the battery may rupture. Misuse can also cause damage to the battery or degradation of battery performance.

**⚠ DANGER! NEVER** leave battery pack in places with temperatures above  $+60^{\circ}\text{C}$  ( $+140^{\circ}\text{F}$ ). High temperature buildup in the battery cells, such as could occur near fires or stoves, inside a sun-heated vehicle, or in direct sunlight for long periods of time may cause the battery cells to rupture or catch fire. Excessive temperatures may also degrade pack's performance or shorten the battery cell's life.

**⚠ DANGER! NEVER** solder the battery cell's terminals, or **NEVER** modify the battery pack. This may cause heat generation, and the battery cells may burst, emit smoke or catch fire.

**⚠ DANGER! NEVER** strike or otherwise impact the battery pack. Do not use the pack if it has been severely impacted or dropped, or if it has been subjected to heavy pressure. Battery damage may not be visible on the outside of the case. Even if the surface of the pack does not show cracks or any other damage, the cells inside the pack may rupture or catch fire.

**⚠ DANGER! NEVER** expose the battery pack to rain, snow, seawater, or any other liquids. Do not charge or use a wet pack. If the pack gets wet, be sure to wipe it dry before using. The battery pack itself is not waterproof.

**⚠ DANGER! NEVER** place battery packs near a fire. Fire or heat may cause them to rupture or explode. Dispose of used packs in accordance with local regulations.

**⚠ DANGER! NEVER** use the battery pack with a transceiver for which it is not specified. Never use a pack with any other equipment, or for any purpose that is not specified in the instruction manual.

**⚠ DANGER! NEVER** let fluid from inside the battery cells get in your eyes. If it does, blindness can result. Rinse your eyes with clean water, without rubbing them, and immediately go to a doctor.

**⚠ WARNING! NEVER** put the battery pack in a microwave oven, high-pressure container, or in an induction heating cooker. This could cause a fire, overheating, or cause the battery cells to rupture.

**⚠ WARNING! NEVER** use the battery pack if it emits an abnormal odor, heats up, or is discolored or deformed. If any of these conditions occur, contact your Icom dealer or distributor.

**⚠ WARNING! NEVER** use deteriorated battery packs. They could cause a fire.

**⚠ WARNING! NEVER** let fluid from inside the battery cells come in contact with your body. If it does, immediately wash with clean water.

**CAUTION: DO NOT** use the battery pack out of the specified temperature range, for the transceiver ( $-25^{\circ}\text{C}$  ~  $+55^{\circ}\text{C}$ ,  $-13^{\circ}\text{F}$  ~  $+131^{\circ}\text{F}$  for European version, or  $-30^{\circ}\text{C}$  ~  $+60^{\circ}\text{C}$ ,  $-22^{\circ}\text{F}$  ~  $+140^{\circ}\text{F}$  for other versions), and the battery pack itself ( $-20^{\circ}\text{C}$  ~  $+60^{\circ}\text{C}$ ,  $-4^{\circ}\text{F}$  ~  $+140^{\circ}\text{F}$ ). Using the pack out of the specified temperature range will reduce its performance and the battery cell's life.

**CAUTION:** Shorter battery pack life could occur if the pack is left fully charged, completely discharged, or in an excessive temperature environment (above  $+50^{\circ}\text{C}$ ,  $+122^{\circ}\text{F}$ ) for an extended period of time. If the battery pack must be left unused for a long time, it must be detached from the transceiver after discharging. You may use the pack until the remaining capacity is about half, then keep it safely in a cool dry place in the following temperature range:

$-20^{\circ}\text{C}$  ( $-4^{\circ}\text{F}$ ) ~  $+50^{\circ}\text{C}$  ( $+122^{\circ}\text{F}$ ) (for a month)  
 $-20^{\circ}\text{C}$  ( $-4^{\circ}\text{F}$ ) ~  $+35^{\circ}\text{C}$  ( $+95^{\circ}\text{F}$ ) (for three months)  
 $-20^{\circ}\text{C}$  ( $-4^{\circ}\text{F}$ ) ~  $+20^{\circ}\text{C}$  ( $+68^{\circ}\text{F}$ ) (for a year)

**BE SURE** to replace the battery pack with a new one approximately five years after manufacturing, even if it still holds a charge. The material inside the battery cells will become weak after a period of time, even with little use. The estimated number of times you can charge the pack is between 300 and 500. Even when the pack appears to be fully charged, the operating time of the transceiver may become short when:

- Approximately five years have passed since the pack was manufactured.
- The pack has been repeatedly charged.

## ⚡ Charging caution

**⚠ DANGER! NEVER** charge the battery pack in areas with extremely high temperatures, such as near fires or stoves, inside a sun-heated vehicle, or in direct sunlight. In such environments, the safety/protection circuit in the pack will activate and stop the charging.

**⚠ WARNING! NEVER** charge the transceiver during a lightning storm. It may result in an electric shock, cause a fire or damage the transceiver. Always disconnect the power adapter before a storm.

**⚠ WARNING! NEVER** charge or leave the battery pack in the battery charger beyond the specified time for charging. If the pack is not completely charged by the specified time, stop charging and remove it from the battery charger. Continuing to charge the pack beyond the specified time limit may cause a fire, overheating, or the battery cells may rupture.

**⚠ WARNING!** Occasionally observe the battery pack condition while charging. If any abnormal condition occurs, discontinue using the battery pack.

**⚠ WARNING! NEVER** insert the transceiver (with the battery pack attached) into the charger if it is wet or soiled. This could corrode the battery charger terminals or damage the charger. The charger is not waterproof.

**CAUTION: DO NOT** charge the battery outside of the specified temperature range:  
BC-160/BC-171  $10^{\circ}\text{C}$  ~  $45^{\circ}\text{C}$  ( $50^{\circ}\text{F}$  ~  $113^{\circ}\text{F}$ )  
BC-119N/BC-121N/BC-197  $10^{\circ}\text{C}$  ~  $40^{\circ}\text{C}$  ( $50^{\circ}\text{F}$  ~  $104^{\circ}\text{F}$ )  
Icom recommends charging the battery at  $20^{\circ}\text{C}$ , ( $68^{\circ}\text{F}$ ). Otherwise, the charging time will be longer, but the battery will not reach a full charge. While charging, at a point after the temperature goes out of the specified range, the charging will automatically stop.

## SAFETY TRAINING INFORMATION



Your Icom radio generates RF electromagnetic energy while transmitting. This radio is designed for and classified as "Occupational Use Only." This means it must be used only during the course of employment by individuals aware of the hazards, and the ways to minimize such hazards. This

radio is NOT intended for use by the "General Population" in an uncontrolled environment. This radio has been tested and complies with the FCC and IC RF exposure limits for "Occupational Use Only". In addition, your Icom radio complies with the following Standards and Guidelines with regard to RF energy and electromagnetic energy levels and evaluation of such levels for exposure to humans:

- FCC KDB Publication 447498 D03, Evaluating Compliance with FCC Guidelines for Human Exposure to Radio Frequency Electromagnetic Fields.
- American National Standards Institute (C95.1-1992), IEEE Standard for Safety Levels with Respect to Human Exposure to Radio Frequency Electromagnetic Fields, 3 kHz to 300 GHz.
- American National Standards Institute (C95.3-1992), IEEE Recommended Practice for the Measurement of Potentially Hazardous Electromagnetic Fields—RF and Microwave.
- The antennas, batteries, belt clips, speaker-microphone, and other accessories that are listed in "OPTIONS" on this sheet, are authorized for use with this product. Use of accessories other than those specified may result in RF exposure levels exceeding the FCC and IC requirements for wireless RF exposure.
- Health Canada Safety Code 6 - Limits of Human Exposure to Electromagnetic Energy in the Frequency Range from 3 kHz to 300 GHz.



To ensure that your exposure to RF electromagnetic energy is within the FCC and IC allowable limits for occupational use, always adhere to the following guidelines:

- **DO NOT** operate the radio without a proper antenna attached, as this may damage the radio and may also cause you to exceed FCC and IC RF exposure limits. A proper antenna is the antenna supplied with this radio by the manufacturer or an antenna specifically authorized by the manufacturer for use with this radio.
- **DO NOT** transmit for more than 50% of the total radio use time ("50% duty cycle"). Transmitting more than 50% of the time can cause FCC and IC RF exposure compliance requirements to be exceeded. The radio is transmitting when the status indicator lights red. You can cause the radio to transmit by pushing the "PTT" switch or VOX function.
- **ALWAYS keep** the antenna at least 2.5 cm (1 inch) away from the body when transmitting, and only use the Icom belt-clips listed in "OPTIONS" on this sheet when attaching the radio to your belt, or other place, to ensure FCC and IC RF exposure compliance requirements are not exceeded. The information listed above provides the user with the information needed to make him or her aware of RF exposure, and what to do to assure that this radio operates within the FCC and IC RF exposure limits of this radio.

**• Electromagnetic Interference/Compatibility**  
During transmissions, your Icom radio generates RF energy that can possibly cause interference with other devices or systems. To avoid such interference, turn off the radio in areas where signs are posted to do so. DO NOT operate the transmitter in areas that are sensitive to electromagnetic radiation such as hospitals, aircraft, and blasting sites.

**• Occupational/Controlled Use**  
The radio transmitter is used in situations in which persons are exposed as a consequence of their employment, provided those persons are fully aware of the potential for exposure and can exercise control over their exposure.

## ABOUT CE AND DOC

Hereby, Icom Inc. declares that the versions of IC-F3262DT, IC-F3262DS, IC-F4262DT, and IC-F4262DS which have the "CE" symbol on the product, comply with the essential requirements of the Radio Equipment Directive, 2014/53/EU, and the restriction of the use of certain hazardous substances in electrical and electronic equipment Directive, 2011/65/EU. The full text of the EU declaration of conformity is available at the following internet address: <https://www.icomjapan.com/support/>

## DISPOSAL



The crossed-out wheeled-bin symbol on your product, literature, or packaging reminds you that in the European Union, all electrical and electronic products, batteries, and accumulators (rechargeable batteries) must be taken to designated collection locations at the end of their working life. Do not dispose of these products as unsorted municipal waste. Dispose of them according to the laws in your area.

## VOICE CODING TECHNOLOGY

The AMBE+2™ voice coding Technology embodied in this product is protected by intellectual property rights including patent rights, copyrights and trade secrets of Digital Voice Systems, Inc. This voice coding Technology is licensed solely for use within this Communications Equipment. The user of this Technology is explicitly prohibited from attempting to extract, remove, decompile, reverse engineer, or disassemble the Object Code, or in any other way convert the Object Code into a human-readable form. U.S. Patent Nos. #8,595,002, #8,359,197, #8,315,860, #8,200,497, #7,970,606, #6,912,495 B2.

## RECOMMENDATION

**CLEAN THE TRANSCEIVER THOROUGHLY IN A BOWL OF FRESH WATER** after exposure to saltwater, and dry it before operating. Otherwise, the transceiver's keys, switches, and controllers may become unusable, due to salt crystallization, and/or the charging terminals of the battery pack may corrode.

**NOTE:** If the transceiver's waterproof protection appears defective, carefully clean it with a soft, damp (fresh water) cloth, then dry it before operating.

The transceiver may lose its waterproof protection if the case, jack cap, or connector cover is cracked or broken, or the transceiver has been dropped, or the battery pack is detached. Contact your Icom distributor or your dealer for advice.

## SUPPLIED ACCESSORIES

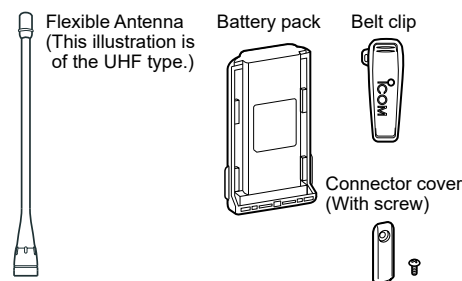

**NOTE:** Some accessories are not supplied, or the shape is different, depending on the transceiver version.

## ⚡ Battery pack

**CAUTION: DO NOT** attach or detach the battery pack when the transceiver is wet or soiled. This may result in water or dust getting into the transceiver/battery pack and may damage the transceiver.

**To attach:**  
Slide the battery pack in the direction of the arrow (➡) until the battery release button makes a 'click' sound.

**NOTE:** Push on the bottom of the pack to confirm the release button is firmly locked.

**To detach:**  
1. Push the battery release button in the direction of the arrow (⬅).  
2. Detach the battery pack.

**NOTE:** Keep the battery pack terminals clean. It's a good idea to occasionally clean them.

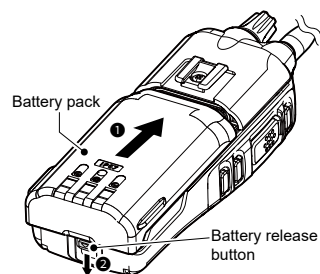

## ⚡ Flexible antenna

Connect the supplied flexible antenna to the antenna connector.

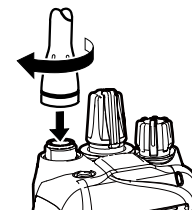

**CAUTION:**  
• **DO NOT** carry the transceiver by holding only the antenna.  
• **DO NOT** connect any antenna other than those listed in the "OPTIONS" section.  
• Transmitting without an antenna may damage the transceiver.

## ⚡ Belt clip

**To attach:**  
1. Remove the battery pack if it is attached.  
2. Slide the belt clip in the direction of the arrow until the belt clip locks and makes a 'click' sound.

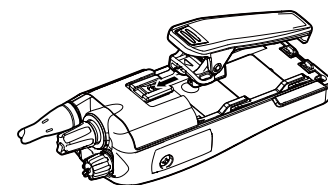

**To detach:**  
1. Remove the battery pack if it is attached.  
2. Gently lift up the clip (➡), and slowly slide the belt clip in the direction of the arrow (⬅).

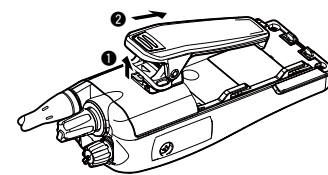

**BE CAREFUL!** Do not break your fingernail.



## PANEL DESCRIPTION

There are 2 types of transceivers in the IC-F3260 and IC-F4260 series.

IC-F3260DS / IC-F4260DS: Simple key type  
IC-F3260DT / IC-F4260DT: Ten-key type

The illustration below shows the Ten-key type transceiver.

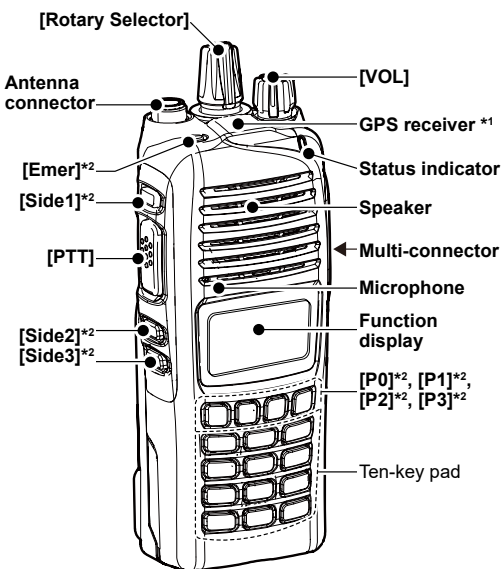

\*1 Built in, depending on the transceiver version.  
\*2 Dealer assignable

### ◇ About the Status indicator

- Lights red while transmitting.
- Lights green while receiving a signal, or when the squelch is open.
- Blinks red when the battery is exhausted.

### ◇ About the Multi-connector

Connects to an optional speaker microphone or headset.

**CAUTION: BE SURE** to attach the connector cover when an optional accessory is not used. The transceiver meets IP67 requirements for dust-tight and waterproof protection only when the connector cover or the optional HM-184/HM-184H is attached.

## ◇ FUNCTION DISPLAY



- SIGNAL STRENGTH ICON**  
Displays the relative receive signal strength.
- LOW POWER ICON**  
Displayed when low output power is selected.  
① When the battery charge decreases to a specified level, low power is automatically selected.
- AUDIBLE ICON**
  - Displayed when the channel is in the audible (unmuted) mode.
  - Displayed when a matching signal is received.
- COMPANDER ICON**  
Displayed when the Compander function is ON.
- SCRAMBLER ICON**  
Displayed when the Voice Scrambler function is ON.
- BELL ICON**  
Displayed when a matching signal is received, depending on the presetting.
- CALL CODE MEMORY ICON**  
Displayed when the call code memory is selected.
- BATTERY ICON**  
Displays the battery level.
 

Indication	Full	Mid	Charging required	Battery exhausted
Battery Status				

  - ① blinks when the battery is exhausted.
- ALPHANUMERIC DISPLAY**
  - Displays the operating channel number, channel name, Set mode contents, DTMF code, and so on.
  - Depending on the presetting, characters are displayed in 1 line or 2 lines on the display.
  - ① In this instruction sheet illustration, characters are displayed in 2 lines.
- KEY ICONS**  
Displays the assigned function of the [P0], [P1], [P2] and [P3] front panel keys.

## BATTERY CHARGING

**NOTE:** Before detaching or attaching a battery pack, BE SURE to turn OFF the transceiver by rotating [VOL] fully counter clockwise, until it makes a "click" sound. Otherwise, a transceiver malfunction could occur.

**IMPORTANT: Battery charging caution**  
Be sure the guide tabs on the battery pack are correctly aligned with the guide rails inside the charger.

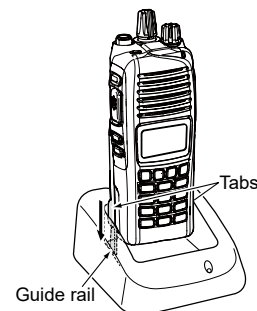

### ◇ Charging with the BC-160/BC-171

You can rapidly charge the Li-ion battery pack with the BC-160, or regularly charge the pack with the BC-171.

#### Charging time for the BP-232WP

BC-160: Approximately 3.5 hours  
BC-171: Approximately 11.5 hours

#### Additionally needed item (purchase separately):

- A power adapter (may be supplied with the charger, depending on the charger version) or the DC power cable (OPC-515L).

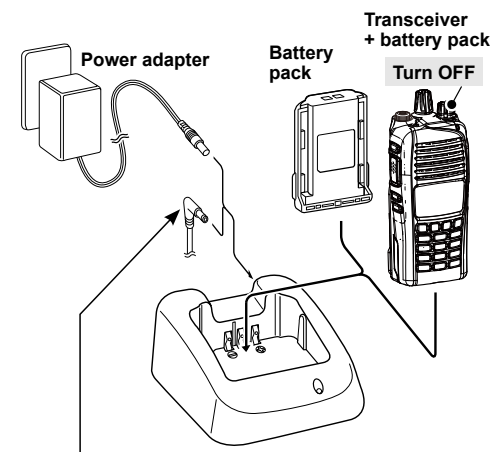

① This illustration is for the BC-160.  
Optional OPC-515L (for a 13.8 V power source) or CP-23L (for a cigarette lighter socket) can be used instead of a power adapter.

### ◇ Rapid charging with the BC-119N+AD-106

You can rapidly charge the Li-ion battery pack with the BC-119N.

#### Charging time for the BP-232WP:

Approximately 3.5 hours

#### Additionally needed item (purchase separately):

- An AD-106 charger adapter
- A power adapter (may be supplied, depending on the charger version) or the DC power cable (OPC-515L/CP-23L)

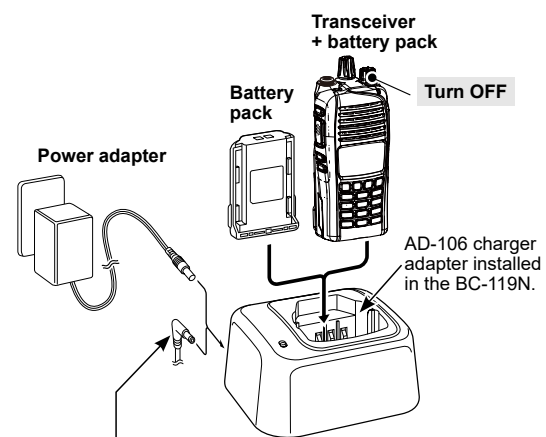

Optional OPC-515L\* (for a 13.8 V power source) or CP-23L (for a 12 V cigarette lighter socket) can be used instead of the power adapter.

\* Polarity of the OPC-515L: White line: ⊕ Black line: ⊖

**CAUTION: DO NOT** reverse the polarity when connecting the OPC-515L or OPC-656 to a power source. This will ruin the battery charger.

### ◇ AD-106 installation

The AD-106 CHARGER ADAPTER must be installed into the BC-119N DESKTOP CHARGER or the BC-121N MULTI-CHARGER before charging the batteries.

1. Connect the BC-119N/BC-121N ribbon cables to the AD-106.
2. Install the AD-106 into the holder space of the BC-119N/BC-121N with the supplied screws.

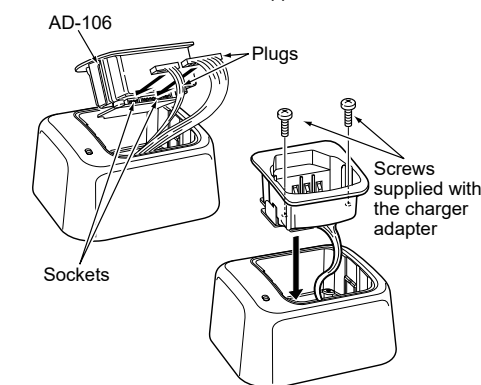

① This illustration is for the BC-119N.

### ◇ Rapid charging with the BC-121N+AD-106

You can rapidly and simultaneously charge up to 6 battery packs with the BC-121N.

#### Charging time for the BP-232WP:

Approximately 3.5 hours

#### Additionally needed item (purchase separately):

- Six AD-106 charger adapters
- A BC-157S power adapter or the OPC-656 DC power cable

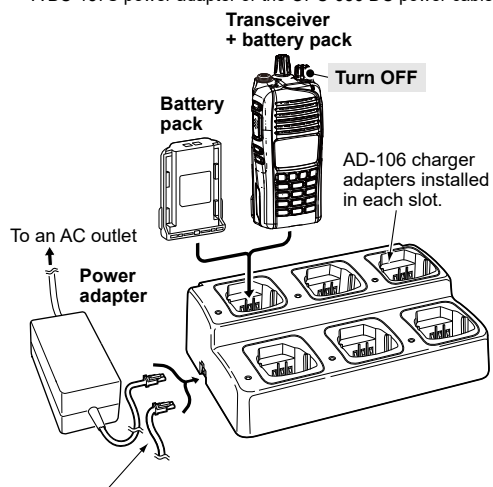

OPC-656\* DC power cable  
Connect to a 13.8 V, 7 A (minimum) power supply  
\* Polarity of the OPC-656: Red line: ⊕ Black line: ⊖

### ◇ Charging with the BC-197+AD-122

You can rapidly and simultaneously charge up to 6 battery packs with the BC-197.

#### Charging time for the BP-232WP:

Approximately 3.5 hours

- ① A power adapter may be supplied, depending on the charger version.
- ② For details on the BC-197 multi-charger, see the instruction manual supplied with the charger.

## BASIC OPERATION

### ◇ Turning ON the transceiver

**NOTE:** Before using the transceiver for the first time, the battery pack must be fully charged for optimum life and operation. See "BATTERY CHARGING" on this sheet.

Rotate [VOL] to turn ON the transceiver.

#### NOTE:

- If the transceiver is programmed for a start up password, enter the digit codes as directed by your dealer.
- The battery type must be selected, according to the attached battery type, when turning on the transceiver.
- ① Ask your dealer about entering the password or selecting the battery type.

### ◇ Receiving and Transmitting

#### Receiving:

1. Select an operating channel.
  - Rotate [Rotary selector].
  - Push [CH Up] or [CH Down].
  - Push one of the direct channel select keys, [MR-CH 1] to [MR-CH 4].
2. When receiving a call, rotate [VOL] to adjust the audio output level.

#### Transmitting:

**CAUTION: DO NOT** transmit without an antenna. It may damage the transceiver.

1. Wait until the channel is clear to avoid interference.
2. Hold down [PTT] to transmit.
3. Release [PTT] to receive.

#### IMPORTANT:

- To maximize the readability of your signal, push [PTT], then pause briefly before you start speaking.
- Hold the microphone 5 to 10 cm from your mouth, then speak at your normal voice level.

## FREQUENCY RANGE AND OUTPUT POWER

Model	Version	Frequency Range	Output Power
VHF Transceivers IC-F3260 series	-	136~174 MHz	5 W
UHF Transceivers IC-F4260 series	USA-03	450~512 MHz	5 W
	USA-04		
	USA-06		
	USA-23		
	USA-24		
	USA-26		
	EXP-07	450~520 MHz	
	EXP-27		
	AUS-01		
	AUS-21		
EXP-04	350~400 MHz		
EXP-05			
EXP-06			
EXP-24			
EXP-25			
EXP-26	400~470 MHz		
DPM-25			
Other			

- Channel spacing: 6.25 kHz\*/12.5 kHz/20 kHz\*\*/25 kHz\*\*
- \*1 Only Digital mode
- \*\*2 Only EUR and DPM versions
- \*\*3 Except USA versions

## OPTIONS

### ◇ BATTERY PACKS

- **BP-240/BP-261 BATTERY CASE**  
Voltage: 7.4 V  
Capacity: 2200 mAh (minimum) 2350 mAh (typical)  
Battery life: Approximately 12 hours  
When the power save function is ON, the GPS function is OFF, and the operating periods are calculated under the following conditions:  
TX:RX:standby = 5 : 5 : 90
- **BP-240/BP-261 BATTERY CASE**  
Battery case for AAA (LR03) × 6 alkaline  
Battery case for AA (LR6) × 6 alkaline  
The BP-240 and BP-261 have IPX4 waterproof protection. When in use, the transceiver's waterproof rating meets IPX4.

### ◇ CHARGERS

- **BC-119N DESKTOP CHARGER + AD-106 CHARGER ADAPTER + BC-145S POWER ADAPTER**  
To rapidly charge battery packs.  
A power adapter may be supplied, depending on the charger version.  
Charging time: Approximately 3.5 hours for the BP-232WP
- **BC-121N MULTI CHARGER + AD-106 CHARGER ADAPTER (6 pieces) + BC-157S AC ADAPTER**  
To simultaneously rapid charge up to 6 battery packs.  
A power adapter may be supplied, depending on the charger version.  
Charging time: Approximately 3.5 hours for the BP-232WP
- **BC-160 DESKTOP CHARGER + BC-145S AC ADAPTER**  
To rapidly charge battery packs.  
A power adapter may be supplied, depending on the charger version.  
Charging time: Approximately 3.5 hours for the BP-232WP
- **BC-171 DESKTOP CHARGER + BC-147S AC ADAPTER**  
To regularly charge battery packs.  
A power adapter may be supplied, depending on the charger version.  
Charging time: Approximately 11 hours for the BP-232WP
- **BC-197 MULTI-CHARGER + AD-122 CHARGER ADAPTER (6 pieces) + BC-157S AC ADAPTER**  
To simultaneously rapid charge up to 6 battery packs.  
A power adapter may be supplied, depending on the charger version.  
Charging time: Approximately 3.5 hours for the BP-232WP

### ◇ DC CABLES

- **CP-23L CIGARETTE LIGHTER CABLES**  
Used when charging battery packs using a 12 V cigarette lighter socket.  
For use with the BC-119N/BC-160/BC-171.
- **OPC-515L/OPC-656 DC POWER CABLES**  
Used when charging battery packs using a 13.8 V DC power source instead of the power adapter.  
OPC-515L: For the BC-119N/BC-160/BC-171  
OPC-656: For the BC-121N/BC-197

### ◇ BELT CLIPS

- **MB-93 SWIVEL BELT CLIP**
- **MB-94R BELT CLIP**  
Alligator-type belt clip.
- **MB-96N/MB-96F LEATHER BELT HANGER**

### ◇ ANTENNAS

- **FA-SC56VS/FA-SC57VS/FA-SC73US STUBBY ANTENNAS**  
Shorter VHF or UHF antennas.  
FA-SC56VS: 150 ~ 162 MHz  
FA-SC57VS: 160 ~ 174 MHz  
FA-SC73US: 450 ~ 490 MHz
- **FA-SC25V/FA-SC55V/FA-SC01U/FA-SC02U/FA-SC03U FA-SC25U/FA-SC57U/FA-SC72U FLEXIBLE ANTENNAS**  
VHF or UHF antennas.  
FA-SC25V: 136 ~ 150 MHz  
FA-SC55V: 150 ~ 174 MHz  
FA-SC01U: 350 ~ 400 MHz  
FA-SC02U: 330 ~ 380 MHz  
FA-SC03U: 380 ~ 430 MHz  
FA-SC25U: 400 ~ 430 MHz  
FA-SC57U: 430 ~ 470 MHz  
FA-SC72U: 470 ~ 520 MHz
- **FA-SC61VC/FA-SC61UC CUT ANTENNAS**  
FA-SC61VC: 136 ~ 174 MHz  
FA-SC61UC: 380 ~ 520 MHz
- **FA-SC62V/FA-SC63V HIGH GAIN ANTENNAS**  
FA-SC62V: 150 ~ 160 MHz  
FA-SC63V: 155 ~ 165 MHz

### ◇ OTHERS

- **AD-118 ACC ADAPTER**  
Connects to an accessory which uses a HIROSE plug. See the instruction sheet of the AD-118 for details of the recommended accessories.
- **CAUTION:** The AD-118 is not waterproof. When it is connected, NEVER expose the adapter and the transceiver to rain, snow or any liquids.
- **HM-184/HM-184H SPEAKER MICROPHONE**  
Rugged type speaker microphones. The HM-184 and HM-184H meet IP67 requirements for dust-tight and waterproof protection.
- **MB-130 VEHICLE CHARGER BRACKET**  
Vehicle mounting bracket for the BC-160 battery charger
- **VS-4MC PTT SWITCH CABLE + HS-94/HS-95/HS-97 HEADSET**  
VS-4MC: Used to connect a headset to a transceiver.  
HS-94: Ear-hook type  
HS-95: Neck-arm type  
HS-97: Throat microphone  
① The VS-4MC meets IP54 requirements for dust-protection and splash resistance.

Some options may not be available in some countries. Ask your dealer for details.