

VHF TRANSCEIVER IC-V10MR

Thank you for choosing this Icom product.
READ ALL INSTRUCTIONS carefully and completely before using this product.

IMPORTANT

SAVE THIS INSTRUCTION MANUAL — This instruction manual contains important operating instructions for the IC-V10MR VHF TRANSCEIVER. The transceiver may have other functions and operations that are not described in this instruction manual. Ask your dealer for details. For more information, download the IC-V10MR operating guide from the Icom web site. (<https://www.icomjapan.com/support/>)

EXPLICIT DEFINITIONS

| WORD | DEFINITION |
|-------------------|-----------------------------------------------------------------------------------------|
| ⚠ DANGER! | Personal death, serious injury or an explosion may occur. |
| ⚠ WARNING! | Personal injury, fire hazard or electric shock may occur. |
| CAUTION | Equipment damage may occur. |
| NOTE | If disregarded, inconvenience only. No risk of personal injury, fire or electric shock. |

Icom is not responsible for the destruction, damage to, or performance of any Icom or non-Icom equipment, if the malfunction is because of:

- Force majeure, including, but not limited to, fires, earthquakes, storms, floods, lightning, other natural disasters, disturbances, riots, war, or radioactive contamination.
- The use of Icom transceivers with any equipment that is not manufactured or approved by Icom.

Icom, Icom Inc. and the Icom logo are registered trademarks of Icom Incorporated (Japan) in Japan, the United States, the United Kingdom, Germany, France, Spain, Russia, Australia, New Zealand, and/or other countries. All other products or brands are registered trademarks or trademarks of their respective holders.

Icom Inc. **Count on us!**
1-1-32 Kamiminami, Hirano-ku, A7619W-1US
Osaka 547-0003, Japan Printed in Japan
Oct. 2020 © 2020 Icom Inc.

SAFETY TRAINING INFORMATION

WARNING Your Icom radio generates RF electromagnetic energy while transmitting. This radio is designed for and classified as for "Occupational Use Only." This means it must be used only during the course of employment by individuals aware of the hazards, and the ways to minimize such hazards. This radio is NOT intended for use by the "General Population" in an uncontrolled environment. This radio has been tested and complies with the FCC RF exposure limits for "Occupational Use Only". In addition, your Icom radio complies with the following Standards and Guidelines with regard to RF energy and electromagnetic energy levels and evaluation of such levels for exposure to humans:

- FCC KDB Publication 447498 D03, Evaluating Compliance with FCC Guidelines for Human Exposure to Radio Frequency Electromagnetic Fields.
- American National Standards Institute (C95.1-2019), IEEE Standard for Safety Levels with Respect to Human Exposure to Electric, Magnetic, and Electromagnetic Fields, 0 Hz to 300 GHz.
- American National Standards Institute (C95.3-2002), IEEE Recommended Practice for Measurements and Computations of Radio Frequency Electromagnetic Fields With Respect to Human Exposure to Such Fields, 100 kHz-300 GHz.
- The antenna, battery, belt clip, speaker-microphone, and other accessories that are listed in "OPTIONS" on this sheet, are authorized for use with this product. Use of accessories other than those specified may result in RF exposure levels exceeding the FCC requirements for wireless RF exposure.

CAUTION To ensure that your exposure to RF electromagnetic energy is within the FCC allowable limits for occupational use, always adhere to the following guidelines:

- **DO NOT** operate the radio without a proper antenna attached, as this may damage the radio and may also cause you to exceed FCC RF exposure limits. A proper antenna is the antenna supplied with this radio by the manufacturer or an antenna specifically authorized by the manufacturer for use with this radio.
- **DO NOT** transmit for more than 50% of the total radio use time ("50% duty cycle"). Transmitting more than 50% of the time can cause FCC RF exposure compliance requirements to be exceeded. The radio is transmitting when the status indicator lights red. You can cause the radio to transmit by pushing the "PTT" switch.
- **ALWAYS keep** the antenna at least 2.5 cm (1 inch) away from the body when transmitting, and only use the Icom belt-clips listed in "OPTIONS" on this sheet when attaching the radio to your belt, or other place, to ensure FCC RF exposure compliance requirements are not exceeded. The information listed above provides the user with the information needed to make him or her aware of RF exposure, and what to do to assure that this radio operates within the FCC RF exposure limits of this radio.

RECOMMENDATION

CLEAN THE TRANSCEIVER THOROUGHLY IN A BOWL OF FRESH WATER after exposure to saltwater, and dry it before operating. Otherwise, the transceiver's keys and switches may become unusable, due to salt crystallization, and/or the charging terminals of the battery pack may corrode.

NOTE: If the transceiver's waterproof protection appears defective, carefully clean the transceiver with a soft, damp (fresh water) cloth, then dry it before operating. The transceiver may lose its waterproof protection if the case, or jack cover is cracked or broken, or the transceiver has been dropped. Contact your Icom distributor or your dealer for advice.

PRECAUTIONS

⚠ WARNING! NEVER use or charge Icom battery packs with non-Icom transceivers or non-Icom chargers. Only Icom battery packs are tested and approved for use with Icom transceivers or charged with Icom chargers. Using third-party or counterfeit battery packs or chargers may cause smoke, fire, or cause the battery to burst.

⚠ WARNING! NEVER hold the transceiver so that the antenna is very close to, or touching exposed parts of the body, especially the face or eyes, while transmitting.

⚠ WARNING! NEVER operate the transceiver with a headset or other audio accessories at high volume levels. The continuous high volume operation may cause a ringing in your ears. If you experience the ringing, reduce the volume level or discontinue use.

CAUTION: DO NOT short the terminals of the battery pack. Shorting may occur if the terminals touch metal objects such as a key, so be careful when placing the battery packs (or the transceiver) in bags, and so on. Carry them so that shorting cannot occur with metal objects. Shorting may damage not only the battery pack, but also the transceiver.

CAUTION: DO NOT use harsh solvents such as Benzene or alcohol when cleaning. This could damage the equipment surfaces. If the surface becomes dusty or dirty, wipe it clean with a soft, dry cloth.

CAUTION: DO NOT place or leave the transceiver in excessively dusty environments. This could damage the transceiver.

NOTE: DO NOT place or leave the transceiver in areas with temperatures below -30°C (-22°F) or above +60°C (+140°F), or in areas subject to direct sunlight, such as the dashboard.

BE CAREFUL! The transceiver meets IP67* requirements for dust tight and waterproof protection. However, once the transceiver has been dropped, dust protection and splash resistance cannot be guaranteed due to the fact that the transceiver may be cracked, or the waterproof seal damaged, and so on.

* Only when the jack cover, the optional HM-168LWP, HS-94LWP, or HS-95LWP is attached.

⚠ Battery caution

Misuse of Li-ion batteries may result in the following hazards: smoke, fire, or the battery may rupture. Misuse can also cause damage to the battery or degradation of battery performance.

⚠ DANGER! NEVER solder the battery terminals, or NEVER modify the battery pack. This may cause heat generation, and the battery may burst, emit smoke or catch fire.

⚠ DANGER! NEVER place or leave battery packs in areas with temperatures above 60°C (140°F). High temperature buildup in the battery cells, such as could occur near fires or stoves, inside a sun-heated vehicle, or in direct sunlight for long periods of time may cause the battery cells to rupture or catch fire. Excessive temperatures may also degrade the battery pack's performance or shorten the battery cell's life.

⚠ DANGER! NEVER strike or otherwise impact the battery pack. Do not use the battery pack if it has been severely impacted or dropped, or if the pack has been subjected to heavy pressure. Battery pack damage may not be visible on the outside of the case. Even if the surface of the battery does not show cracks or any other damage, the cells inside the battery may rupture or catch fire.

⚠ DANGER! NEVER place battery packs near a fire. Fire or heat may cause them to rupture or explode. Dispose of used battery packs in accordance with local regulations.

⚠ DANGER! NEVER let fluid from inside the battery get in your eyes. This can cause blindness. Rinse your eyes with clean water, without rubbing them, and immediately get medical treatment from an eye doctor.

⚠ WARNING! NEVER put the battery pack in a microwave oven, high-pressure container, or in an induction heating cooker. This could cause a fire, overheating, or cause the battery cells to rupture.

⚠ WARNING! NEVER let fluid from inside the battery cells come in contact with your body. If it does, immediately wash with clean water.

CAUTION: DO NOT continue to use the battery pack if it emits an abnormal odor, heats up, or is discolored or deformed. If any of these conditions occur, contact your Icom dealer or distributor.

CAUTION: DO NOT expose the battery pack to rain, snow, saltwater, or any other liquids. Do not charge or use a wet pack. If the pack gets wet, be sure to wipe it with a clean dry cloth before using.

CAUTION: DO NOT use the battery pack out of the specified temperature range for the transceiver -30°C (-22°F) or above +60°C (+140°F), and the battery itself -20°C ~ +60°C (-4°F ~ +140°F). Using the battery out of its specified temperature range will reduce its performance and battery cell's life. Please note that the specified temperature range of the battery may exceed that of the transceiver. In such cases, the transceiver may not work properly because it is out of its operating temperature range.

CAUTION: DO NOT leave the pack fully charged, completely discharged, or in an excessive temperature environment (above 50°C, 122°F) for an extended period of time. If the battery pack must be left unused for a long time, it must be detached from the transceiver after discharging. You may use the battery pack until the remaining capacity is about half, then keep it safely in a cool and dry place at the following temperature range:

-20°C ~ +50°C (-4°F ~ +122°F) (within a month)
-20°C ~ +40°C (-4°F ~ +104°F) (within three months)
-20°C ~ +20°C (-4°F ~ +68°F) (within a year)

BE SURE to replace the battery pack with a new one approximately five years after manufacturing, even if it still holds a charge. The material inside the battery cells will become weak after a period of time, even with little use. The estimated number of times you can charge the pack is between 300 and 500. Even when the pack appears to be fully charged, the operating time of the transceiver may become short when:

- Approximately 5 years have passed since the pack was manufactured.
- The pack has been repeatedly charged.

⚠ Charging caution

⚠ DANGER! NEVER charge the battery pack in areas with extremely high temperatures, such as near fires or stoves, inside a sun-heated vehicle, or in direct sunlight. In such environments, the safety/protection circuit in the battery will activate, causing the battery to stop charging.

⚠ WARNING! NEVER charge the transceiver during a lightning storm. It may result in an electric shock, cause a fire or damage the transceiver. Always disconnect the power adapter before a storm.

⚠ WARNING! NEVER charge or leave the battery in the battery charger beyond the specified time for charging. If the battery is not completely charged by the specified time, stop charging and remove the battery from the battery charger.

Continuing to charge the battery beyond the specified time limit may cause a fire, overheating, or the battery may rupture.

CAUTION: DO NOT insert the transceiver (battery attached to the transceiver) into the charger if it is wet or soiled. This could corrode the battery charger terminals or damage the charger. The charger is not waterproof.

CAUTION: DO NOT charge the battery pack outside of the specified temperature range: 10°C to 40°C (50°F to 104°F). Icom recommends charging the pack at 25°C (77°F). The pack may heat up or rupture if charged out of the specified temperature range. Additionally, pack's performance or battery cell life may be reduced.

CAUTION: DO NOT use the power adapter unless the power outlet is easily accessible and near the unit. Remove it from the AC power outlet when not in use.

SUPPLIED ACCESSORIES

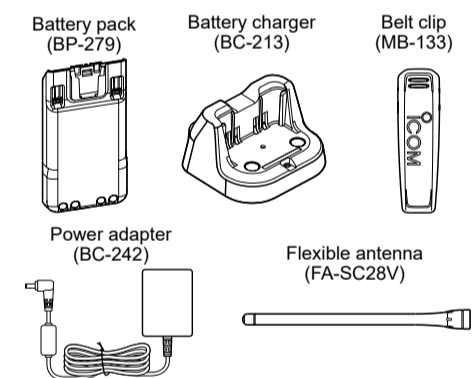

NOTE: Some accessories are not supplied, or the shape is different, depending on the transceiver version.

⚠ Battery pack

Attaching:

1. Slide the battery pack in the direction of the arrow. (1)
2. Push the battery pack until the battery sliding locks make a 'click' sound. (2)

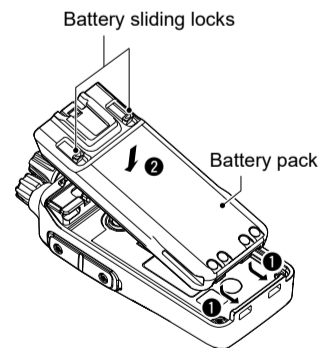

Detaching:

1. Push both battery sliding locks in the direction of the arrow. (1)
- The battery pack is then released.
2. Lift up to detach the battery pack. (2)

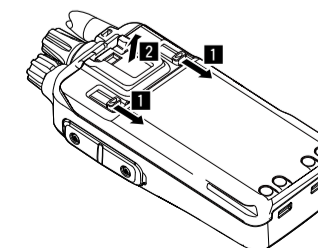

⚠ Flexible antenna

Connect the antenna to the antenna connector.

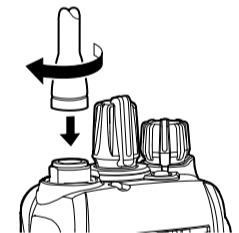

CAUTION:

- **DO NOT** carry the transceiver by holding only the antenna.
- **DO NOT** connect an antenna other than the specified antenna.
- **DO NOT** transmit without an antenna.

⚠ Belt clip

Attaching:

1. Remove the battery pack from the transceiver, if it is attached.
2. Slide the belt clip in the direction of the arrow until the belt clip is locked and makes a 'click' sound.

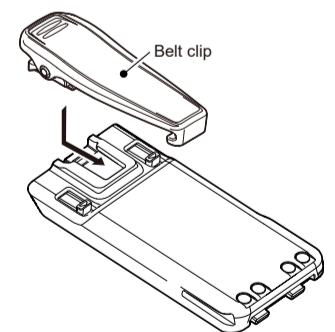

Detaching:

- Lift the tab up (1), and slide the belt clip in the direction of the arrow (2).

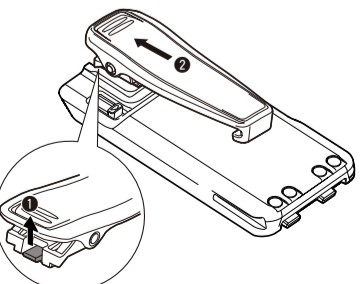

BE CAREFUL! DO NOT break your fingernail.

PANEL DESCRIPTION

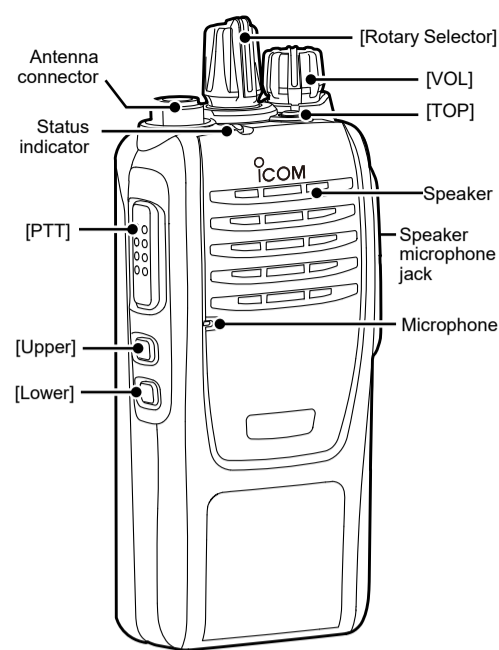

◇ Status indicator

Lights red: Transmitting.
 Lights green: Receiving or squelch is open.
 Lights or blinks orange: A matching signal is received, depending on the presetting.
 Slowly blinks green: The battery should be charged.
 Blinks green fast: The battery must be charged.

◇ About the keys

[TOP]: Push to turn the Channel Announce function ON or OFF.
 [Upper]: Push to turn the monitor function ON or OFF.
 [Lower]: No function is assigned in default.

NOTE: Other functions can be assigned to these keys with the CS-V10MR programming software.

◇ Speaker microphone jack

CAUTION: DO NOT use the transceiver without the jack cover or the optional equipment attached. The transceiver meets IP67 requirements for dust-tight and waterproof protection only when the jack cover or the optional HM-168LWP, HS-94LWP, or HS-95LWP is attached.

BATTERY CHARGING

NOTE: Before detaching or attaching a battery pack, BE SURE to turn OFF the transceiver by rotating [VOL] fully counter clockwise, until it makes a "click" sound. Otherwise, a transceiver malfunction could occur.

◇ Rapid charging with the BC-213

You can rapidly charge the Li-ion battery pack with the BC-213.

Charging time:
 Approximately 2.5 hours for the BP-279

Additionally needed item (purchase separately):
 • A power adapter (may be supplied with the charger, depending on the charger version).

CAUTION:

- NEVER reverse the polarity when connecting the OPC-515L to a power source. This will ruin the battery charger.
- Stop charging if the charge indicator alternately lights orange and green.

NOTE: Charge the battery within the specified temperature range of 10°C ~ 40°C (50°F ~ 104°F). Otherwise, the charging time will be longer, but the battery will not reach a full charge. While charging, at a point after the temperature goes out of the specified range, the charging will automatically stop.

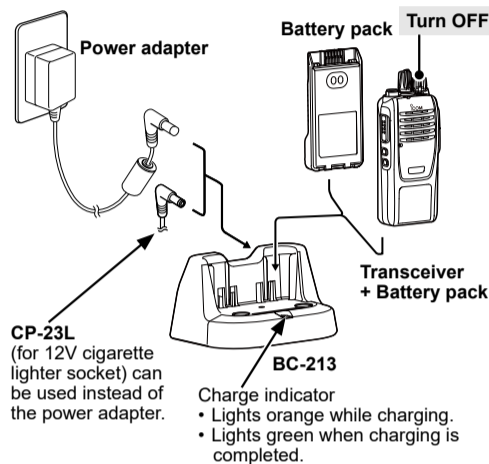

NOTE: If the charging indicator alternately blinks green and orange, remove the battery pack or the transceiver from the charger, then reinsert it.

◇ Rapid charging with the BC-214

You can rapidly and simultaneously charge up to 6 battery packs with the optional BC-214 (the AD-130 CHARGER ADAPTERS are installed.)

Charging time:
 Approximately 2.5 hours for the BP-279

Additionally needed item (purchase separately):
 • The BC-157S AC ADAPTER or the OPC-656 DC POWER CABLE

CAUTION: DO NOT reverse the polarity when connecting the OPC-656 to a power source. This will ruin the battery charger.
 Red: ⊕, Black: ⊖

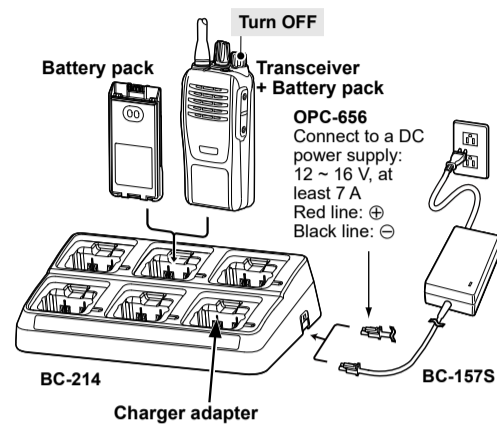

NOTE: The BC-214 has a charging timer that stops charging after approximately 5.3 hours of charging.

BASIC OPERATION

◇ Turning ON the transceiver

NOTE: Before using the transceiver for the first time, the battery pack must be fully charged for optimum life and operation.

- Rotate [VOL] to turn ON the transceiver.

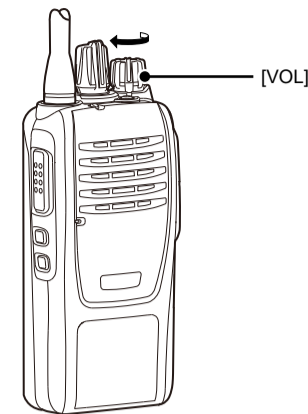

◇ Receiving and Transmitting

CAUTION: DO NOT transmit without an antenna.

Receiving:
 1. Rotate [Rotary Selector] to select a channel.
 2. When receiving a call, rotate [VOL] to adjust the audio output level to a comfortable listening level.

NOTE: Push [Upper] to listen on the channel, to confirm that no one is operating on the channel before transmitting.

Transmitting:
 1. Wait until the channel is clear to avoid interference.
 2. While holding down [PTT], speak at your normal voice level.
 3. Release [PTT] to receive.

IMPORTANT:
 To maximize the readability of your signal:
 1. After pushing [PTT], pause briefly before you start speaking.
 2. Hold the microphone 5 ~ 10 cm (2 ~ 4 inches) from your mouth, then speak at your normal voice level.

OPTIONS

◇ BATTERY PACK

• BP-279 BATTERY PACK

| Battery pack | Voltage | Capacity | Approximate battery life* |
|--------------|---------|------------------------------------------|---------------------------|
| BP-279 | 7.2 V | 1485 mAh (minimum) 1570 mAh (typical) | 16 hours |

* When the power save function is turned ON, and the operating periods are calculated under the following conditions.
 TX : RX : standby = 5 : 5 : 90 TX Power 2 W

◇ CHARGERS

- **BC-213 DESKTOP CHARGER**
 To rapidly charge a single battery pack. A power adapter may be supplied, depending on the charger version.
- **BC-214 MULTI CHARGER + BC-157S AC ADAPTER**
 To rapidly charge up to 6 battery packs.

◇ DC CABLES

- **CP-23L CIGARETTE LIGHTER CABLE**
 Use when charging the battery pack from a 12 V cigarette lighter socket. (Use with the BC-213)
- **OPC-656 DC POWER SOCKET**
 Use with a 13.8 V power source instead of the power adapter. (Use with the BC-214)

◇ ANTENNA

- **FA-SC28V VHF ANTENNA**
 148 ~ 162 MHz

◇ OTHERS

- **MB-130 CHARGER BRACKET**
 Mounts the BC-213 desktop charger on a variety of places in a vehicle.
- **MB-133 BELT CLIP**
- **HM-158LA/HM-159LA/HM-168LWP SPEAKER MICROPHONE**
 Combination speaker-microphone that provides convenient operation while the transceiver is hanging on your belt.
 ⊕ Adjust the microphone gain before use.
- **HM-153LA/HM-166LA EARPHONE MICROPHONE**
 Ideal for hands-free operation. Clip the HM-153LA or HM-166LA (with integrated PTT switch) to your lapel or breast pocket.
 ⊕ Adjust the microphone gain before use.
- **HS-94/HS-95/HS-97 HEADSET + VS-4LA PTT SWITCH CABLE/ OPC-2004LA ADAPTER CABLE**
 HS-94: Ear-hook type
 HS-95: Neck-arm type
 HS-97: Throat microphone
 VS-4LA: To connect to headsets
 OPC-2004LA: To connect to headsets for VOX operation
 ⊕ Adjust the both microphone and VOX gain before use.

- **HS-94LWP/HS-95LWP HEADSET**
 HS-94LWP: Ear-hook type
 HS-95LWP: Neck-arm type
 ⊕ Adjust the both microphone and VOX gain before use.
- **CS-V10MR PROGRAMING SOFTWARE + OPC-478UC PROGRAMING CABLE**
 Provides quick and easy programming of such settings as memory channels and Set modes contents. Ask your dealer for details.
 You can download the CS-V10MR Programming software from the Icom web site.
 (<https://www.icomjapan.com/support/>)

DEFAULT FREQUENCIES CHART

| Channel | Frequency (MHz) | CTCSS Tone (Hz) | Band Width | TX PWR (W) |
|---------|-----------------|-----------------|------------|------------|
| Ch 1 | 151.820 | 67.0 | Narrow | 2 |
| Ch 2 | 151.880 | | | |
| Ch 3 | 151.940 | | | |
| Ch 4 | 154.570 | | | |
| Ch 5 | 154.600 | | | |

Ⓛ Channel 6 to 16 are not programmed by default. Ask your dealer for details.

USER SET MODE

You can set the Beep function, Beep level, the Ringer level, the squelch level, the microphone gain, the VOX function, and the VOX gain with key operation and hearing beeps.

◇ User setting operation

Turning the Beep function ON or OFF

NOTE: Turn ON the Beep function when you set the Beep level, the Ringer level, the microphone gain, the VOX function, the VOX gain, and the squelch level.

1. Rotate [VOL] to turn OFF the transceiver.
2. Set [Rotary Selector] to any channel other than Channel 16.
3. While holding down [Lower], rotate [VOL] to turn ON the transceiver.
 • The transceiver enters the Beep level set mode.
4. Push [Lower] to turn the Beep function ON or OFF.
 ⊕ If a beep sounds after pushing [Lower], the Beep function is ON. If no beep sounds after pushing [Lower], the Beep function is OFF.
 ⊕ The transceiver saves the setting every time you change it.
 ⊕ If desired, push [Upper] to adjust the Beep level.
5. Rotate [VOL] to turn OFF the transceiver, then turn ON again to restart the normal operation.

Setting the Beep level

NOTE: The Beep function should be ON.

1. Rotate [VOL] to turn OFF the transceiver.
2. Set [Rotary Selector] to any channel other than Channel 16.
3. While holding down [Lower], rotate [VOL] to turn ON the transceiver.
 • An opening beep sounds, and the selected channel number will be announced.
 ⊕ The transceiver can announce the number only when the selected channel is programmed.
 • The transceiver enters the Beep level set mode.
4. Push [Upper] to change the Beep level.
 • Beep at the set level sounds every time you push [Upper].
 ⊕ Repeatedly pushing [Upper] changes the Beep level, as shown below.

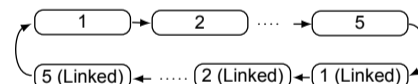

- Ⓛ The settable range: 1 to 5 and 1 (Linked) to 5 (Linked). When setting the Linked option, the Beep level is adjustable with [VOL].
5. Rotate [VOL] to turn OFF the transceiver, then turn ON again to restart the normal operation.

Setting the Ringer level

NOTE: The Beep function should be ON.

1. Rotate [VOL] to turn OFF the transceiver.
2. Set [Rotary Selector] to Channel 16.
3. While holding down [Lower], rotate [VOL] to turn ON the transceiver.
 • An opening beep sounds and the selected channel number will be announced.
 ⊕ The transceiver can announce the number only when the selected channel is programmed.
 • The transceiver enters the Ringer level set mode.
4. Push [Upper] to increase, or push [Lower] to decrease the Ringer level.
 • Beep at the set level sounds every time you push [Upper] or [Lower].
 ⊕ Repeatedly pushing [Upper] or [Lower] changes the Ringer level, as shown below.

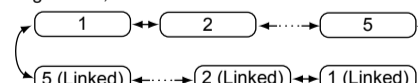

- Ⓛ The settable range is 1 to 5 or 1 (Linked) to 5 (Linked). When setting the Linked option, the Ringer level is adjustable with [VOL].
5. Rotate [VOL] to turn OFF the transceiver, then turn ON again to restart the normal operation.

Setting the squelch level

The squelch circuit mutes the received audio signal, depending on the signal strength.

NOTE: The Beep function should be ON.

1. Rotate [VOL] to turn OFF the transceiver.
2. Set [Rotary Selector] to any channel other than Channel 16.
3. While holding down [Upper], rotate [VOL] to turn ON and enter the squelch level adjustment mode.
4. Push [Upper] to increase the squelch level or push [Lower] to decrease the squelch level.
 ⊕ The settable range is between 0 (open) to 9 (tight).
 • A beep sounds after pushing [Upper] or [Lower]. An error beep sounds if the settable range is exceeded.
5. Rotate [VOL] to turn OFF the transceiver, then turn ON again to restart the normal operation.

Setting the microphone gain

The higher value makes the microphone more sensitive to the user's voice.

NOTE: The Beep function should be ON.

1. Rotate [VOL] to turn OFF the transceiver.
2. Set [Rotary Selector] to Channel 16.
3. While holding down [Upper], rotate [VOL] to turn ON the transceiver and enter the microphone gain adjustment mode.
 ⊕ The adjustable range is between 1 (low sensitivity) to 4 (high sensitivity).
 • A beep sounds after pushing [Upper] or [Lower]. An error beep sounds if the adjustable range is exceeded.
5. Rotate [VOL] to turn OFF the transceiver, then turn ON again to restart the normal operation.

Setting the VOX function

The VOX function can be turned ON or OFF. The VOX function automatically switches between receive and transmit during voice operation.

NOTE: The Beep function should be ON.

1. Rotate [VOL] to turn OFF the transceiver.
2. Set [Rotary Selector] to any channel other than Channel 16.
3. While holding down [PTT] and [Upper], rotate [VOL] to turn ON the transceiver and turn the VOX function ON or OFF.
 ⊕ The adjustable range is between 1 (low sensitivity) to 4 (high sensitivity).
 • A beep sounds after pushing [Upper] or [Lower]. An error beep sounds if the settable range is exceeded.
4. Rotate [VOL] to turn OFF the transceiver, then turn ON again to restart the normal operation.

Setting the VOX Gain

The higher value makes the VOX function more sensitive to the user's voice.

NOTE: The Beep function should be ON.

1. Rotate [VOL] to turn OFF the transceiver.
2. Set [Rotary Selector] to Channel 16.
3. While holding down [PTT] and [Upper], rotate [VOL] to turn ON the transceiver and turn the VOX function ON or OFF.
 ⊕ The adjustable range is between 1 (low sensitivity) to 4 (high sensitivity).
 • A beep sounds after pushing [Upper] or [Lower]. An error beep sounds if the settable range is exceeded.
4. Rotate [VOL] to turn OFF the transceiver, then turn ON again to restart the normal operation.